



konstrukcja

Promieniowy wentylator kanałowy z silnikiem oddzielnym od strumienia przepływającego powietrza. Obudowa w najwyższej klasie szczelności L1 (wg. EN 1886), wykonana z galwanizowanej blachy stalowej ma kształt sześcianu składającego się z ramy i paneli bocznych, izolowanych (poza panelem wlotowym) warstwą wełny mineralnej o grubości 30mm. W wykonaniu standardowym wlot stanowi wyprofilowany pierścień bez króćca przyłączeniowego. Wylot uzyskuje się przez zdjęcie jednego z izolowanych paneli bocznych. Wylot można skonfigurować względem wlotu tylko pod kątem 90°. Po stronie wylotu zastosować można panele USB wyposażone w okrągłe króćce przyłączeniowe lub paneleUSR z redukcją do przyłącza okrągłego. Po stronie wlotu istnieje możliwość montażu okrągłych króćców wlotowych ASB. W celu ograniczenia dodatkowych oporów, które powstaną przy stosowaniu powyższych paneli i króćców należy zwrócić szczególną uwagę na zachowanie odcinków prostych kanałów oraz króćców o jak największej średnicy przyłączeniowej. W podstawie wentylatora zlokalizowany został króciec skroplin (gwint wewnętrzny). Instalacja powinna być wyposażona w stosowne filtry / łapaczki tłuszczu.

wirnik

Wirnik nowej generacji wyważony dynamicznie w klasie G2,5, typu B - z łopatkami pochylonymi do tyłu, wykonany z blachy stalowej malowanej proszkowo.

napięcie i sterowanie

Jednofazowy (230V, 50Hz, IP54, klasa izolacji F) lub trójfazowy (400V, 50Hz, IP55, klasa izolacji F) asynchroniczny silnik elektryczny zlokalizowany całkowicie poza strumieniem usuwanego powietrza.

Prędkość obrotowa modeli jednofazowych może być kontrolowana przy pomocy regulatorów transformatorowych. Zalecany zakres regulacji napięcia 110-230V. Silniki te posiadają czujniki temperatury uzwojeń typu termokontakt, które muszą być podłączone i monitorowane przez zewnętrzne urządzenie ochrony termicznej, np. automatykę, przekaźnik wbudowany w regulator, przekaźnik SET 10 itp.

Prędkość obrotowa modeli z silnikami trójfazowymi (3x230Δ/3x400Y) może być kontrolowana za pomocą przemienników częstotliwości, wyłącznie w zakresie częstotliwości (obrotów) podanych w tabeli/wykresie doboru. Zalecany czas przyspieszania i hamowania przetwornicą (rampa): 20-30 sek.

W przypadku bezpośredniego podłączenia silników trójfazowych do sieci należy je zabezpieczyć przy pomocy wyłączników silnikowych z wbudowanym wyzwalaczem zwarciovym i przeciążeniowym.

Nastawa wyzwalacza termicznego wyłącznika silnikowego musi być dostosowana do rzeczywistych parametrów pracy wentylatora i nie wyższa niż wartość I_{max} dla wentylatora.

maksymalna temperatura pracy

60 ± 80°C - temperatura medium dla modeli z silnikami jednofazowymi

120°C - temperatura medium dla modeli z silnikami trójfazowymi.

zastosowanie

Efektywny odciąg oparów z kuchni przemysłowych w obiektach gastronomicznych. Możliwość zastosowania we wszelkich instalacjach odciągowych wymagających odprowadzania powietrza o podwyższonej temperaturze.

Akcesoria



GS
wyłącznik serwisowy



STRS-1
regulator transformatorowy



iGSA
przebiegnik częstotliwości



WPH
osłona wlotu / wylotu



USB
panel boczny na wylot



RCP
osłona dachowa



WPS
żaluzja na wylot



ASB
króciec wlotowy



USR
panel boczny na wylot z redukcją



FB
moduł filtracyjny

tablica doboru akcesoriów dla danego wentylatora MBCK

Typ MBCK	225/1700S	250/2600S	280/3300S	315/3800S	400/4500S	450/6000S	500/7800S
Wyłącznik serwisowy	GS 01	GS 01	GS 01	GS 01	GS 01	GS 01	GS 01
5-bieg. reg. wbudowane zabezp. termiczne	STRS-1-35L22	STRS-1-50L22	STRS-1-50L22	STRS-1-100L22	STRS-1-35L22	STRS-1-50L22	STRS-1-100L22
Zabezpieczenie termiczne	S-ET 10	S-ET 10	S-ET 10	S-ET 10	S-ET 10	S-ET 10	-
Osłona silnika	MBS 01	MBS 01	MBS 01	MBS 01	MBS 02	MBS 02	MBS 02
Panel boczny na wylot	USB 01/02	USB 02	USB 02	USB 02	USB 03/04/05	USB 04/05	USB 04/05
Panel boczny na wylot z redukcją	USR 01/02	USR 01/02	USR 01/02	USR 01/02	USR 04/05/06	USR 04/05/06	USR 04/05/06
Osłona wlotu/wylotu	WPH 01	WPH 01	WPH 01	WPH 01	WPH 02	WPH 02	WPH 02
Osłona dachowa	RCP 01	RCP 01	RCP 01	RCP 01	RCP 02	RCP 02	RCP 02
Rama montażowa	BAF 01	BAF 01	BAF 01	BAF 01	BAF 02	BAF 02	BAF 02
Króciec wlotowy	ASB 01/02/03	ASB 03	ASB 03	ASB 03	ASB 04/05/06	ASB 05/06	ASB 05/06
Żaluzja na wylot	WPS 01	WPS 01	WPS 01	WPS 02	WPS 02	WPS 02	WPS 02
Moduł filtracyjny	FB 500	FB 500	FB 500	FB 500	FB 700	FB 700	FB 700

Typ MBCK	225/2000T	250/2600T	280/2800T	315/4100T	315/3300T	355/4600T	400/4800T
Wyłącznik serwisowy	GS 03	GS 03	GS 03	GS 03	GS 03	GS 03	GS 03
Wyłącznik silnikowy	1,0 - 1,6 A	1,0 - 1,6 A	1,0 - 1,6 A	2,5 - 4,0 A	1,0 - 1,6 A	1,0 - 1,6 A	1,0 - 1,6 A
Przebiegnik częstotliwości 1x230V/3x230V	SV008iCS-1F	SV008iCS-1F	SV008iCS-1F	SV015iCS-1F	SV008iCS-1F	SV008iCS-1F	SV008iCS-1F
Przebiegnik częstotliwości 3x400V/3x400V	SV008iGSA-4	SV008iGSA-4	SV008iGSA-4	SV015iGSA-4	SV008iGSA-4	SV008iGSA-4	SV008iGSA-4
Osłona silnika	MBS 01	MBS 01	MBS 01	MBS 01	MBS 01	MBS 02	MBS 02
Panel boczny na wylot	USB 01/02	USB 02	USB 02	USB 02	USB 02	USB 03/04/05	USB 03/04/05
Panel boczny na wylot z redukcją	USR 01/02/03	USR 02/03	USR 02/03	USR 02/03	USR 02/03	USR 04/05/06	USR 04/05/06
Osłona wlotu/wylotu	WPH 01	WPH 01	WPH 01	WPH 01	WPH 01	WPH 02	WPH 02
Osłona dachowa	RCP 01	RCP 01	RCP 01	RCP 01	RCP 01	RCP 02	RCP 02
Rama montażowa	BAF 01	BAF 01	BAF 01	BAF 01	BAF 01	BAF 02	BAF 02
Króciec wlotowy	ASB 01/02/03	ASB 03	ASB 03	ASB 03	ASB 03	ASB 04/05/06	ASB 04/05/06
Żaluzja na wylot	WPS 01	WPS 01	WPS 01	WPS 01	WPS 01	WPS 02	WPS 02
Moduł filtracyjny	FB 500	FB 500	FB 500	FB 500	FB 500	FB 700	FB 700

tablica doboru akcesoriów dla danego wentylatora MBCK

Typ MBCK	450/7100T	500/8100T	560/13100T	630/17500T	710/19500T	800/22600T
Wyłącznik serwisowy	GS 03	GS 03	GS 03	GS 03	GS 03	GS 03
Wyłącznik silnikowy	2,5 - 4,0 A	2,5 - 4,0 A	4,0 - 6,3 A	6,3 - 10 A	6,3 - 10 A	6,3 - 10 A
Przebiegnik częstotliwości 1x230V/3x230V	SV015iC5-1F	SV015iC5-1F	SV022iC5-1F	-	-	-
Przebiegnik częstotliwości 3x400V/3x400V	SV015iG5A-4	SV015iG5A-4	SV022iG5A-4	SV040iG5A-4	SV040iG5A-4	SV040iG5A-4
Ochrona silnika	MBS 02	MBS 02	MBS 03	MBS 03	MBS 04	MBS 04
Panel boczny na wylot	USB 04/05	USB 04/05	USB 07/08	USB 07/08	USB 09/10	USB 09/10
Panel boczny na wylot z redukcją	USR 04/05/06	USR 04/05/06	USR 07/08	USR 07/08	USR 09/10	USR 09/10
Ochrona wlotu/wylotu	WPH 02	WPH 02	WPH 03	WPH 03	WPH 04	WPH 04
Ochrona dachowa	RCP 02	RCP 02	RCP 03	RCP 03	RCP 04	RCP 04
Rama montażowa	BAF 02	BAF 02	BAF 03	BAF 03	BAF 04	BAF 04
Króciec wlotowy	ASB 05/06	ASB 05/06	ASB 07/08	ASB 07/08	ASB 09	ASB 09
Żaluzja na wylot	WPS 02	WPS 02	WPS 03	WPS 03	WPS 04	WPS 04
Moduł filtracyjny	FB 700	FB 700	FB 900	FB 900	FB 1200	FB 1200

dane techniczne

Typ	V _{max} [m ³ /h]	ΔP _{max} [Pa]	P _{max} [W]	U [V]	I _{max} [A]	RPM _{max} [1/min]	t _{max} [°C]	L _{WA} [dB(A)]	L _{PA} [dB(A)]	m [kg]	nr katalogowy
MBCK 225/1700S	1740	660	285	230	2,1	2920	80	67	60	36	13788500
MBCK 250/2600S	2610	790	454	230	3,4	2950	80	73	66	44	12667900
MBCK 280/3300S	3340	980	703	230	4,1	2910	80	75	68	46	12668100
MBCK 315/3800S	4225	1270	1319	230	7,6	2930	80	74	67	45	13682900
MBCK 400/4500S	4590	510	499	230	2,8	1450	80	63	56	59	13688700
MBCK 450/6000S	5960	640	793	230	4,5	1450	65 (80)*	70	63	73	12662400
MBCK 500/7800S	7800	815	1429	230	7,9	1460	80	71	64	81	14118600

* w nawiasie podana maksymalna temperatura przetwarzanego medium podczas pracy bez regulacji prędkości obrotowej

Typ	V _{max} [m ³ /h]	ΔP _{max} [Pa]	P _{max} [W]	P _{nom} [W]	U [V]	I _{max} [A]	F _{nom} [Hz]	f _{min} - f _{max} [Hz]	RPM _{max} [1/min]	RPM _{nom} [1/min]	t _{max} * [°C]	L _{WA} [dB(A)]	L _{PA} [dB(A)]	m [kg]	nr katalogowy
MBCK 225/2000T	2010	940	440	291	3~230/400(Δ/Y)	0,85	50	20-60	3520	2920	60	73	66	35	15720600
MBCK 250/2600T	2630	1130	692	438	3~230/400(Δ/Y)	1,2	50	20-60	3490	2870	60	73	66	35	15720900
MBCK 280/2800T	2830	980	686	686	3~230/400(Δ/Y)	1,26	50	20-50	2920	2790	60	73	66	36	15721400
MBCK 315/4100T	4115	1270	1208	1208	3~230/400(Δ/Y)	2,45	50	20-50	2950	2860	60	75	68	41	15721800
MBCK 315/3300T	3300	810	658	221	3~230/400(Δ/Y)	1,13	50	20-80	2360	1480	60	68	61	40	15722400
MBCK 355/4600T	4590	810	793	338	3~230/400(Δ/Y)	1,37	50	20-70	2060	1470	60	76	69	40	15722600
MBCK 400/4800T	4840	505	564	564	3~230/400(Δ/Y)	1,1	50	20-50	1470	1440	60	69	62	65	15723100
MBCK 450/7100T	7125	810	1226	967	3~230/400(Δ/Y)	2,5	50	20-55	1630	1470	60	73	66	73	15723200
MBCK 500/8100T	8090	840	1440	1440	3~230/400(Δ/Y)	2,85	50	20-50	1485	1450	60	77	70	75	15723300
MBCK 560/13100T	13060	1040	2661	2661	3~230/400(Δ/Y)	5	50	20-50	1470	1430	60	76	69	127	15723500
MBCK 630/17500T	17540	1330	4325	4325	3~230/400(Δ/Y)	8,8	50	20-50	1480	1452	60	79	72	140	15724100
MBCK 710/19500T	19550	735	2761	2761	3~400/690(Δ/Y)	7	50	20-50	990	980	60	70	63	235	15094500
MBCK 800/22600T	22610	920	4772	4518	3~400/690(Δ/Y)	9,4	50	20-50	990	970	60 (120)	71	66	241	15096000

* Max temperatura otoczenia. Temperatura medium dla modeli trójfazowych wynosi 120°C, w nawiasie podana maksymalna temperatura przetwarzanego medium podczas pracy bez regulacji prędkości obrotowej

wymiary

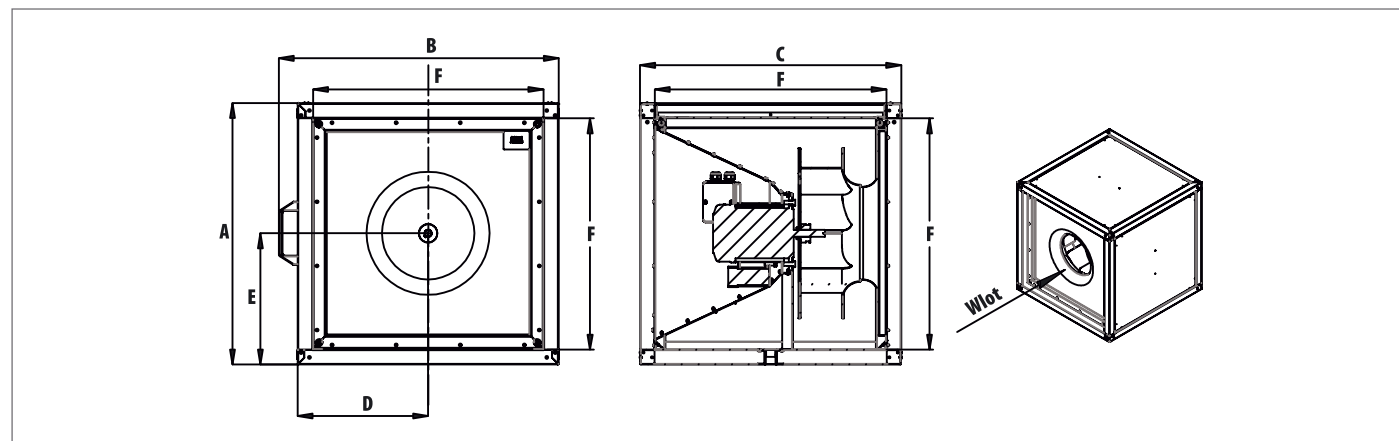

wymiary

Typ	A [mm]	B [mm]	C [mm]	D [mm]	E [mm]	F x F [mm]
MBCK 225	500	552	500	250	250	417x417
MBCK 250	500	552	500	250	250	417x417
MBCK 280	500	552	500	250	250	417x417
MBCK 315	500	552	500	250	250	417x417
MBCK 355	700	752	700	350	350	617x617
MBCK 400	700	752	700	350	350	617x617
MBCK 450	700	752	700	350	350	617x617
MBCK 500	700	752	700	350	350	617x617
MBCK 560	900	952	900	450	450	817x817
MBCK 630	900	952	900	450	450	817x817
MBCK 710	1200	1252	1200	600	600	1117x1117
MBCK 800	1200	1252	1200	600	600	1117x1117

Schematy podłączenia elektrycznego

Możliwe warianty lokalizacji wylotu (bok lub góra).
Silnik znajduje się poza przepływem czynnika.

dla modeli MBCK 1~230V

dla modeli MBCK 3~400V Y
(3~230V Δ)

dla modeli MBCK 3~400V Δ

charakterystyki pracy

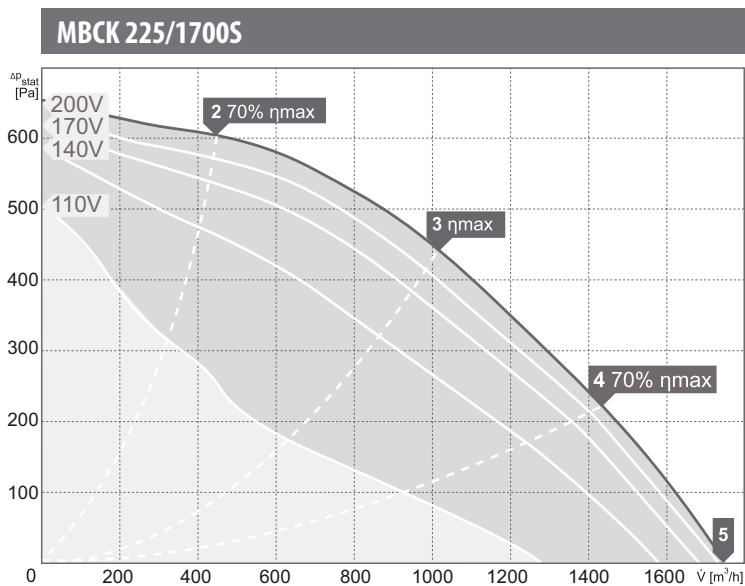

wartości mocy akustycznej L_{WA} [dB(A)]
dla poszczególnych częstotliwości pasm oktaowych [Hz]

Pkt. Pracy	tot	Częstotliwości pasm oktaowych [Hz]							
		63	125	250	500	1000	2000	4000	8000
L_{WA} wlot [dB(A)]									
2	73	53	59	65	65	67	65	62	58
3	71	52	53	60	64	65	64	61	57
4	75	56	52	69	68	68	67	65	58
5	78	59	55	73	71	70	69	69	60
L_{WA} wylot [dB(A)]									
2	76	62	68	68	67	69	70	64	57
3	75	56	65	65	66	69	69	62	56
4	78	48	62	67	68	72	74	70	59
5	80	51	60	69	70	74	76	72	64
L_{WA} od obudowy [dB(A)]									
2	68	56	59	56	57	61	61	60	57
3	67	55	53	58	58	60	61	58	57
4	69	62	53	62	61	61	62	58	52
5	71	65	53	64	63	62	63	59	53

charakterystyki pracy

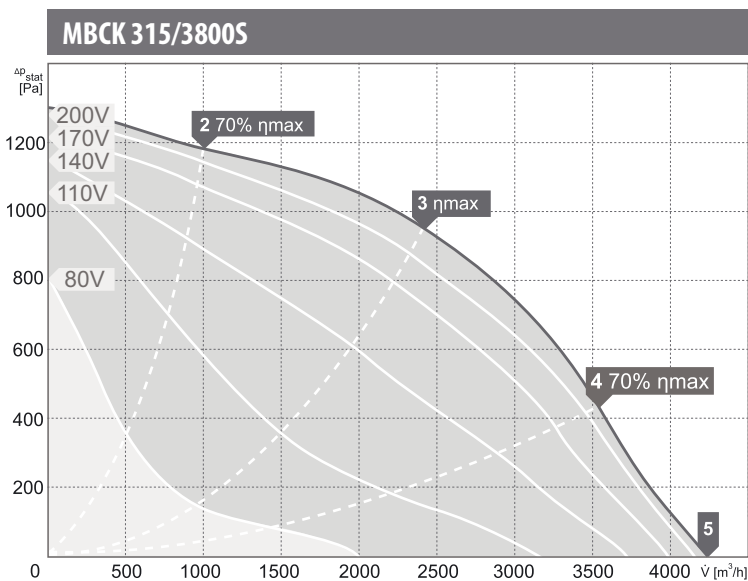
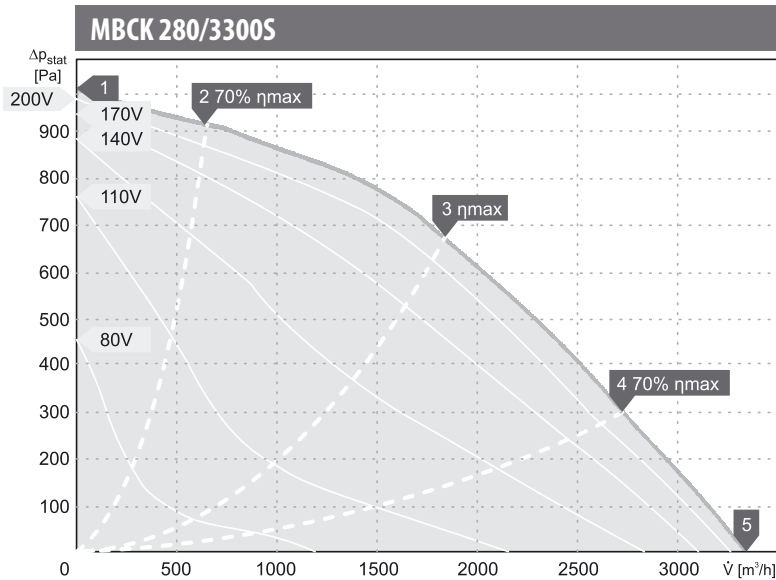
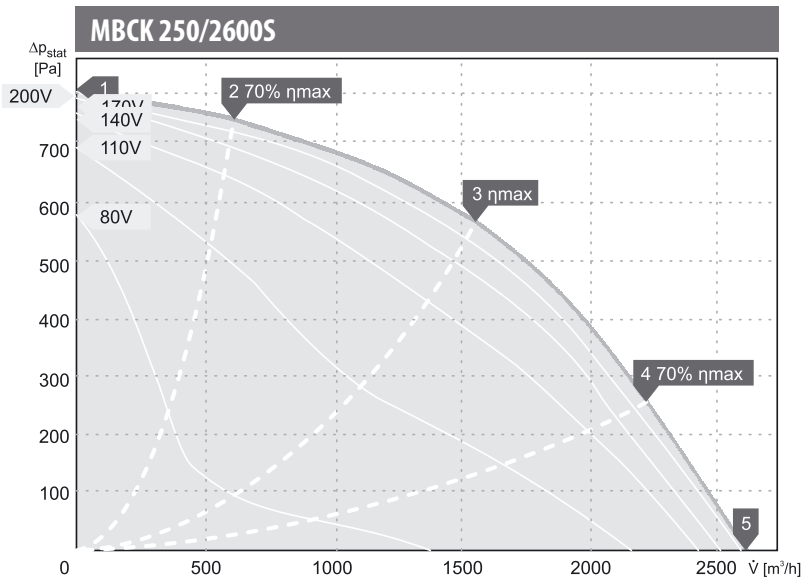

wartości mocy akustycznej L_{WA} [dB(A)]
dla poszczególnych częstotliwości pasm oktaowych [Hz]

Pkt. Pracy	Częstotliwości pasm oktaowych [Hz]								
	tot	63	125	250	500	1000	2000	4000	8000
L_{WA} wlot [dB(A)]									
2	77	53	59	67	70	70	70	69	63
3	77	54	57	67	71	70	70	68	63
4	80	55	56	71	75	73	73	72	64
5	83	51	59	74	77	75	75	74	72
L_{WA} wylot [dB(A)]									
2	80	59	63	72	72	74	74	70	65
3	79	53	56	70	71	74	74	70	65
4	83	53	57	74	75	77	78	75	69
5	85	59	61	75	77	79	80	78	73
L_{WA} od obudowy [dB(A)]									
2	73	61	58	59	64	67	67	66	61
3	73	62	57	60	66	68	67	65	60
4	73	65	55	62	65	68	67	64	59
5	75	61	58	64	68	70	69	65	60

Pkt. Pracy	Częstotliwości pasm oktaowych [Hz]								
	tot	63	125	250	500	1000	2000	4000	8000
L_{WA} wlot [dB(A)]									
2	81	55	70	74	75	74	74	72	67
3	80	54	62	70	73	72	73	71	66
4	82	57	65	75	78	75	74	71	65
5	85	55	66	77	81	78	78	75	69
L_{WA} wylot [dB(A)]									
2	82	57	71	76	75	76	76	71	63
3	82	59	63	74	74	76	76	72	64
4	86	57	67	77	79	81	80	74	66
5	88	55	67	79	81	83	83	78	72
L_{WA} od obudowy [dB(A)]									
2	78	57	66	68	68	70	71	70	66
3	75	53	59	64	66	69	70	68	64
4	76	56	61	69	69	69	69	65	61
5	77	60	63	71	71	71	70	66	62

Pkt. Pracy	Częstotliwości pasm oktaowych [Hz]								
	tot	63	125	250	500	1000	2000	4000	8000
L_{WA} wlot [dB(A)]									
2	85	58	74	79	79	76	76	74	67
3	83	50	59	74	77	75	77	76	69
4	86	54	63	79	80	79	79	77	70
5	89	53	67	81	84	82	80	78	72
L_{WA} wylot [dB(A)]									
2	88	57	74	83	80	80	79	75	68
3	85	51	63	79	77	79	78	74	68
4	89	51	67	84	82	84	82	76	68
5	91	53	68	82	85	86	84	79	74
L_{WA} od obudowy [dB(A)]									
2	78	59	74	69	67	68	68	66	60
3	74	52	61	66	66	68	68	65	60
4	76	55	64	70	68	69	69	65	59
5	78	58	64	73	70	70	70	66	59

charakterystyki pracy

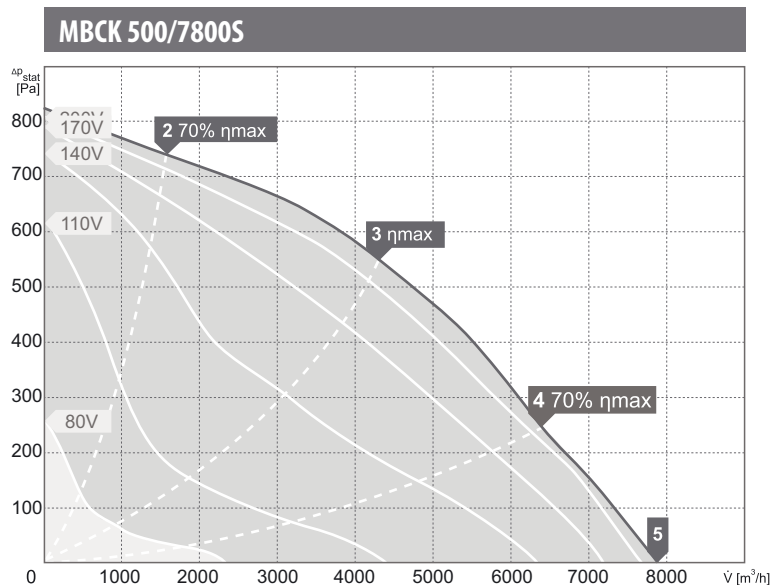
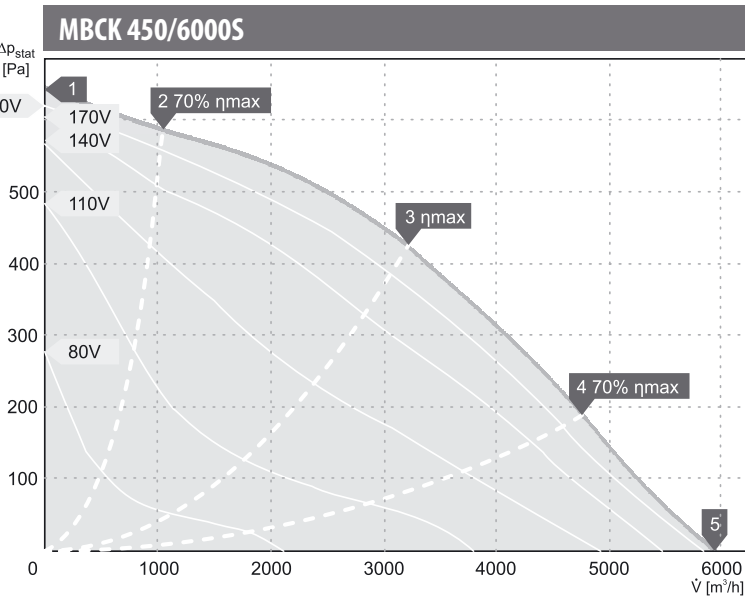
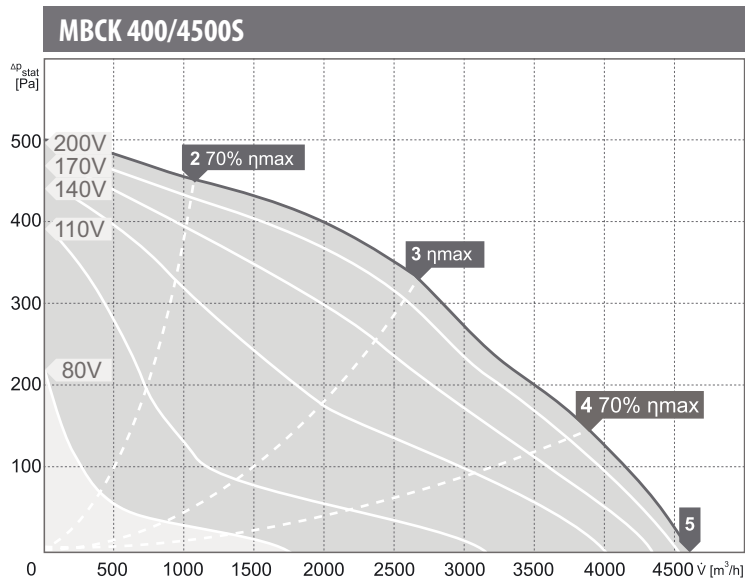

wartości mocy akustycznej L_{WA} [dB(A)]
dla poszczególnych częstotliwości pasm oktaowych [Hz]

Pkt. Pracy	tot	Częstotliwości pasm oktaowych [Hz]							
		63	125	250	500	1000	2000	4000	8000
L_{WA} wlot [dB(A)]									
2	72	51	65	64	66	64	62	58	52
3	71	40	63	63	66	64	62	58	54
4	76	42	69	68	71	69	67	63	61
5	79	44	72	70	73	71	70	68	64
L_{WA} wylot [dB(A)]									
2	75	53	67	65	68	70	65	60	57
3	74	40	61	61	67	70	66	61	58
4	77	44	67	67	72	73	68	64	62
5	81	46	69	71	74	76	72	71	65
L_{WA} od obudowy [dB(A)]									
2	65	53	62	53	58	56	53	52	47
3	63	40	60	51	57	56	51	50	43
4	65	44	63	55	57	56	51	48	41
5	67	47	63	58	58	57	54	51	43

Pkt. Pracy	tot	Częstotliwości pasm oktaowych [Hz]							
		63	125	250	500	1000	2000	4000	8000
L_{WA} wlot [dB(A)]									
2	76	53	68	67	69	69	67	63	58
3	76	46	69	67	71	70	67	62	61
4	80	48	72	72	74	73	70	64	63
5	83	50	76	75	76	76	74	69	66
L_{WA} wylot [dB(A)]									
2	79	55	70	69	73	75	71	66	56
3	79	47	68	69	74	75	71	66	57
4	82	49	73	73	77	77	72	67	60
5	86	52	78	77	80	81	77	74	65
L_{WA} od obudowy [dB(A)]									
2	70	54	62	59	63	65	60	59	56
3	70	53	63	60	64	64	60	56	58
4	72	55	67	63	66	65	59	53	48
5	74	58	70	65	67	66	59	53	43

Pkt. Pracy	tot	Częstotliwości pasm oktaowych [Hz]							
		63	125	250	500	1000	2000	4000	8000
L_{WA} wlot [dB(A)]									
2	81	60	76	72	74	74	74	69	61
3	80	49	69	71	74	74	73	69	61
4	83	53	75	75	77	77	74	69	66
5	85	54	77	76	78	78	77	73	68
L_{WA} wylot [dB(A)]									
2	85	60	79	74	79	80	77	72	63
3	84	49	73	72	78	78	76	72	63
4	87	53	76	77	82	82	77	72	66
5	89	55	79	78	83	83	80	76	68
L_{WA} od obudowy [dB(A)]									
2	73	61	69	66	64	61	59	61	56
3	71	54	66	63	64	60	59	59	54
4	74	58	71	67	67	62	60	59	54
5	77	60	74	69	69	65	62	61	55

charakterystyki pracy

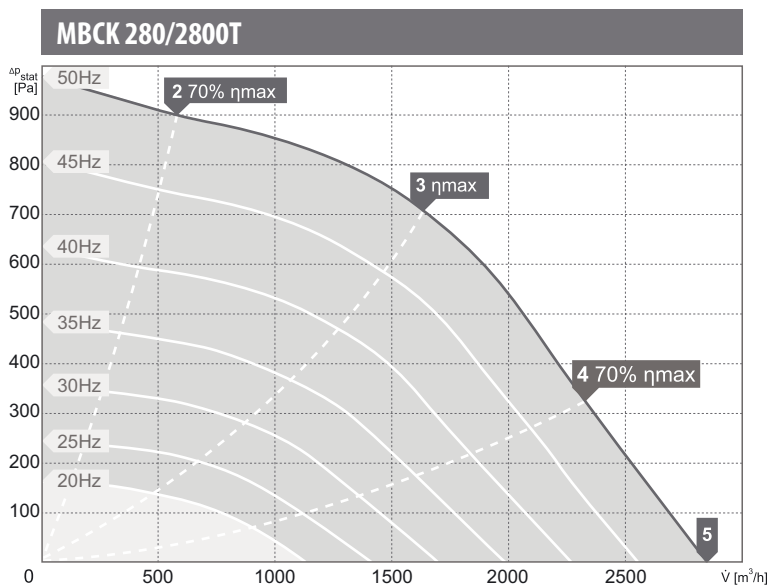
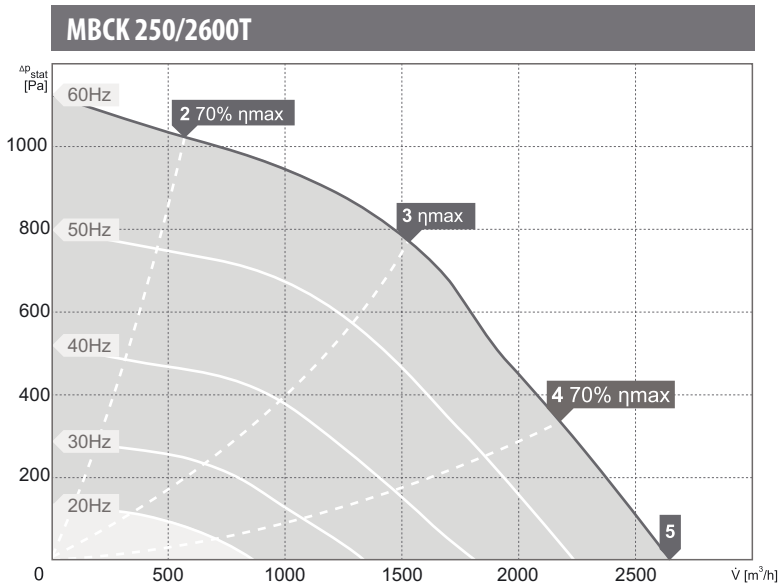
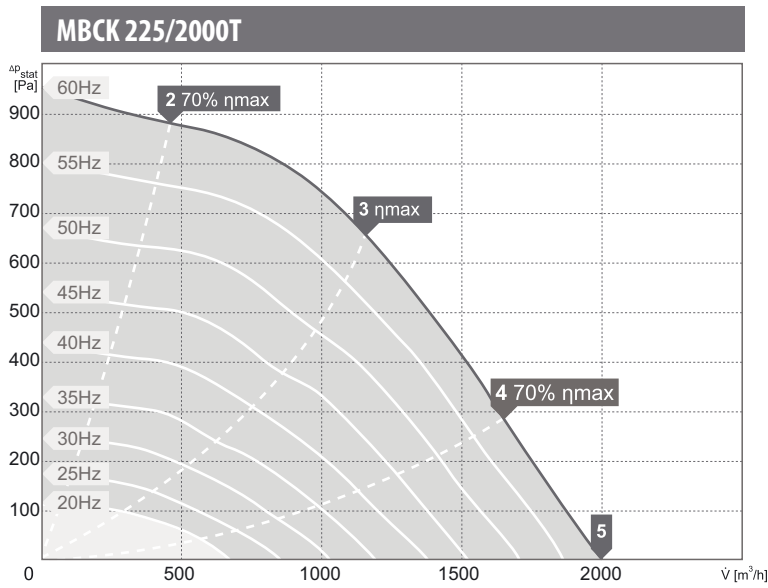

wartości mocy akustycznej L_{WA} [dB(A)]
dla poszczególnych częstotliwości pasm oktaowych [Hz]

Pkt. Pracy	Częstotliwości pasm oktaowych [Hz]								
	tot	63	125	250	500	1000	2000	4000	8000
L_{WA} wlot [dB(A)]									
2	80	53	68	71	73	75	72	69	62
3	80	51	63	67	73	77	73	70	63
4	84	51	63	74	76	81	75	73	69
5	85	49	66	76	79	81	77	75	73
L_{WA} wylot [dB(A)]									
2	82	52	69	74	76	76	76	70	63
3	83	47	66	70	77	78	78	71	63
4	87	46	66	76	80	81	82	76	71
5	88	49	68	76	81	82	84	79	75
L_{WA} od obudowy [dB(A)]									
2	74	52	66	61	66	68	69	64	57
3	73	49	61	58	65	68	69	63	56
4	74	48	62	61	67	68	69	64	56
5	75	52	66	64	68	69	70	65	58

Pkt. Pracy	Częstotliwości pasm oktaowych [Hz]								
	tot	63	125	250	500	1000	2000	4000	8000
L_{WA} wlot [dB(A)]									
2	81	53	70	74	74	76	72	69	62
3	82	51	64	68	76	78	73	69	62
4	87	51	64	76	81	83	76	74	74
5	88	50	67	74	82	83	79	77	77
L_{WA} wylot [dB(A)]									
2	84	57	73	78	79	78	77	71	63
3	84	52	68	73	79	79	78	71	63
4	88	49	65	78	83	83	83	75	72
5	89	50	67	78	83	84	84	78	77
L_{WA} od obudowy [dB(A)]									
2	75	56	69	63	65	67	68	63	57
3	73	56	62	59	66	68	68	63	56
4	74	53	63	64	68	68	69	63	56
5	75	50	66	64	69	68	69	64	58

Pkt. Pracy	Częstotliwości pasm oktaowych [Hz]								
	tot	63	125	250	500	1000	2000	4000	8000
L_{WA} wlot [dB(A)]									
2	81	58	73	76	74	73	72	69	66
3	82	50	66	73	77	74	74	70	68
4	86	50	71	81	81	79	76	72	69
5	88	53	71	82	84	81	79	76	71
L_{WA} wylot [dB(A)]									
2	84	59	73	79	77	77	77	71	65
3	85	54	68	77	78	80	78	70	65
4	89	54	72	82	82	83	81	73	68
5	91	55	73	84	85	86	84	77	73
L_{WA} od obudowy [dB(A)]									
2	74	58	69	65	62	66	65	60	55
3	73	51	62	65	62	69	65	60	54
4	74	52	67	69	66	68	65	60	54
5	77	57	69	72	69	68	68	62	55

charakterystyki pracy

MBCK 315/4100T

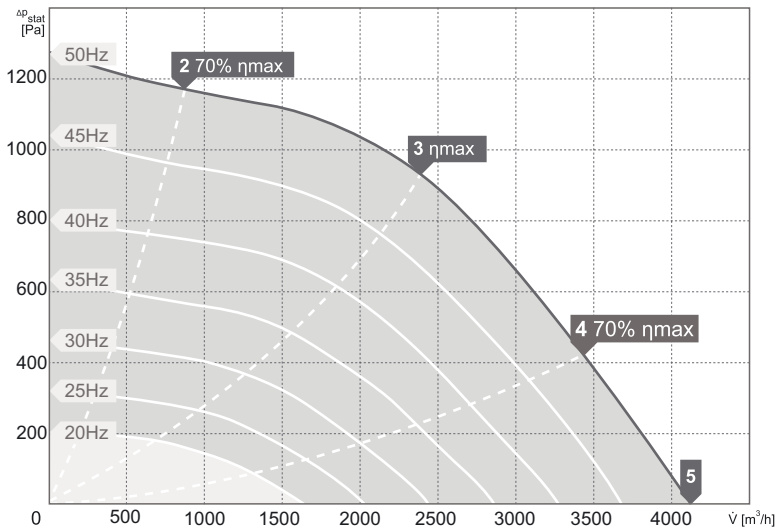

MBCK 315/3300T

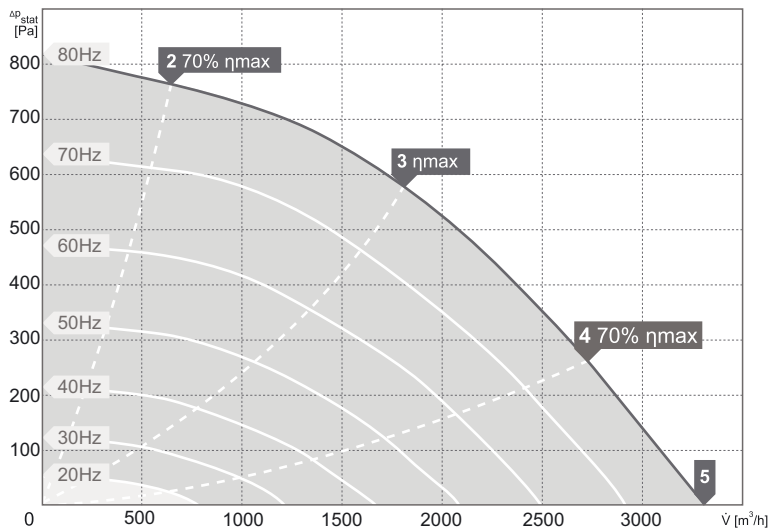

MBCK 355/4600T

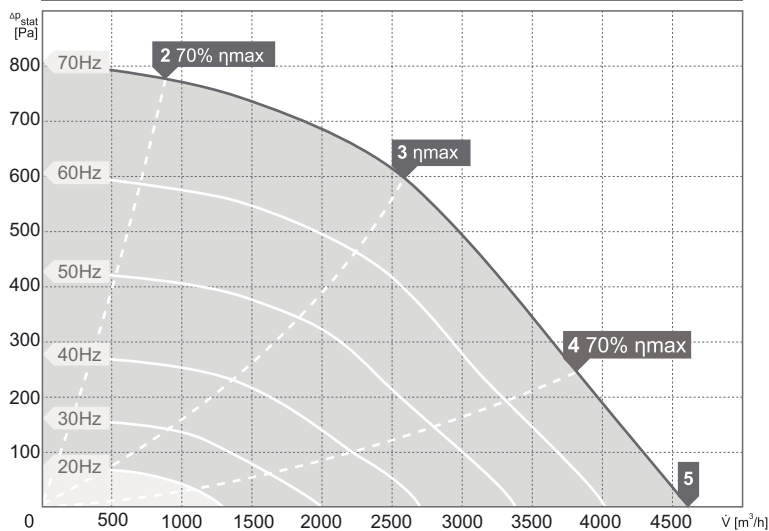

wartości mocy akustycznej L_{WA} [dB(A)]
dla poszczególnych częstotliwości pasm oktaowych [Hz]

Pkt. Pracy	Częstotliwości pasm oktaowych [Hz]								
	tot	63	125	250	500	1000	2000	4000	8000
L_{WA} wlot [dB(A)]									
2	85	59	76	80	79	76	76	74	69
3	85	51	66	77	80	78	78	75	71
4	89	52	69	83	84	82	80	77	72
5	90	53	70	82	85	83	83	82	75
L_{WA} wylot [dB(A)]									
2	88	60	74	83	81	81	80	76	70
3	88	56	66	82	81	83	82	78	73
4	92	55	70	85	85	87	85	79	74
5	93	58	72	87	86	88	86	82	77
L_{WA} od obudowy [dB(A)]									
2	76	61	71	68	65	67	67	65	59
3	75	55	63	69	66	68	68	64	58
4	78	57	67	74	69	70	69	65	58
5	79	59	68	75	71	70	71	68	60

Pkt. Pracy	Częstotliwości pasm oktaowych [Hz]								
	tot	63	125	250	500	1000	2000	4000	8000
L_{WA} wlot [dB(A)]									
2	79	55	67	73	73	70	70	68	62
3	78	47	59	70	73	70	71	68	64
4	82	45	63	75	77	75	73	69	66
5	83	47	62	74	79	76	76	74	68
L_{WA} wylot [dB(A)]									
2	82	56	68	76	74	75	74	68	61
3	81	48	60	74	74	76	75	70	64
4	85	45	62	75	78	80	78	72	66
5	86	48	64	78	80	82	80	75	69
L_{WA} od obudowy [dB(A)]									
2	69	58	64	62	59	59	62	55	48
3	68	51	58	59	60	58	64	54	49
4	69	47	59	60	62	60	65	55	50
5	70	48	61	62	63	61	64	57	50

Pkt. Pracy	Częstotliwości pasm oktaowych [Hz]								
	tot	63	125	250	500	1000	2000	4000	8000
L_{WA} wlot [dB(A)]									
2	79	53	66	70	76	70	69	67	61
3	79	43	56	69	76	70	71	68	63
4	83	44	62	76	80	75	74	73	66
5	86	48	63	77	82	77	78	76	71
L_{WA} wylot [dB(A)]									
2	83	59	71	74	79	77	74	70	67
3	84	45	58	72	80	78	75	72	70
4	86	49	64	75	82	81	78	74	70
5	89	52	66	79	84	83	81	79	73
L_{WA} od obudowy [dB(A)]									
2	76	52	64	61	76	63	63	55	53
3	76	43	54	57	76	64	65	56	53
4	78	45	59	61	78	67	66	58	56
5	80	48	62	64	79	70	68	62	56

charakterystyki pracy

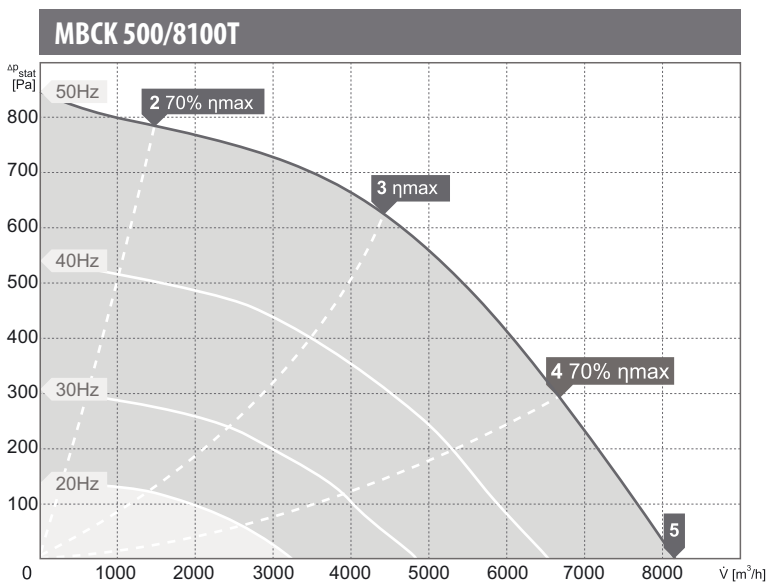
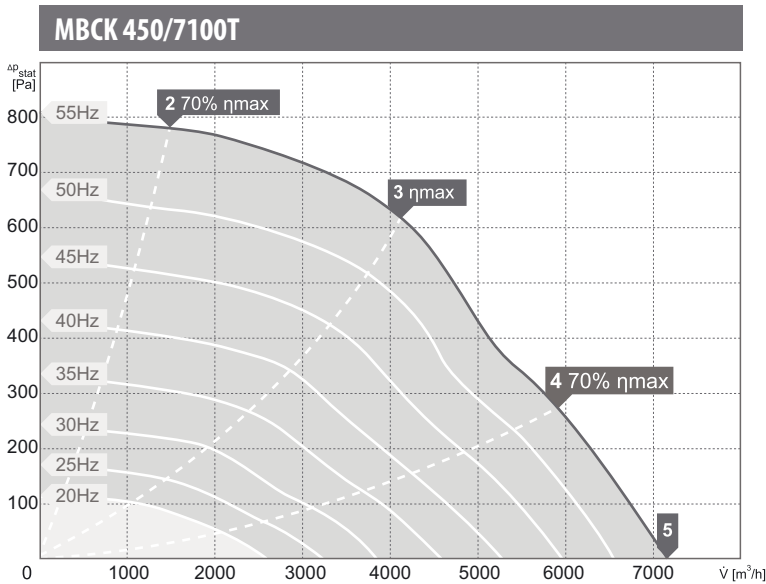
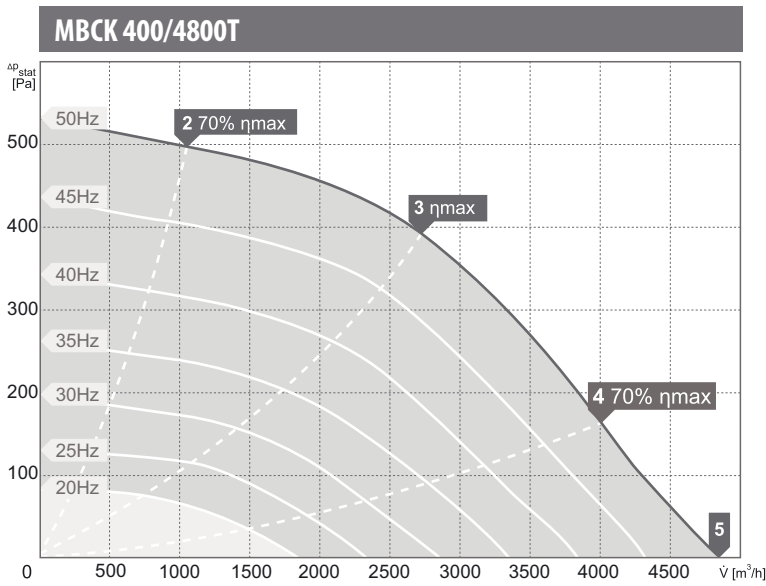

wartości mocy akustycznej L_{WA} [dB(A)]
dla poszczególnych częstotliwości pasm oktaowych [Hz]

Pkt. Pracy	Częstotliwości pasm oktaowych [Hz]								
	tot	63	125	250	500	1000	2000	4000	8000
L_{WA} wlot [dB(A)]									
2	73	48	64	64	69	66	63	60	57
3	74	41	67	65	70	66	63	60	58
4	78	45	71	70	73	70	68	69	61
5	80	46	72	71	73	71	71	73	64
L_{WA} wylot [dB(A)]									
2	75	52	66	65	69	70	66	61	56
3	76	41	65	66	70	71	67	62	57
4	80	44	68	70	74	75	71	70	59
5	82	44	70	73	75	77	74	75	63
L_{WA} od obudowy [dB(A)]									
2	69	50	60	58	66	60	52	45	40
3	69	41	61	59	66	61	54	45	38
4	69	45	63	60	65	61	54	48	38
5	70	47	66	61	64	59	55	52	41

Pkt. Pracy	Częstotliwości pasm oktaowych [Hz]								
	tot	63	125	250	500	1000	2000	4000	8000
L_{WA} wlot [dB(A)]									
2	80	55	69	72	74	74	73	70	64
3	82	51	67	75	76	75	73	69	65
4	85	54	72	80	80	78	76	71	68
5	87	53	72	80	81	80	80	77	71
L_{WA} wylot [dB(A)]									
2	83	55	70	74	77	78	76	72	63
3	85	51	67	77	79	80	76	72	64
4	88	53	71	79	83	84	80	76	66
5	90	55	72	81	84	85	82	79	68
L_{WA} od obudowy [dB(A)]									
2	72	56	65	65	66	64	62	59	54
3	73	54	64	68	67	65	62	59	54
4	76	58	69	72	71	67	63	59	51
5	77	62	71	73	71	67	66	61	53

Pkt. Pracy	Częstotliwości pasm oktaowych [Hz]								
	tot	63	125	250	500	1000	2000	4000	8000
L_{WA} wlot [dB(A)]									
2	85	60	75	75	79	80	79	74	64
3	86	51	75	74	79	80	79	74	64
4	88	55	77	77	83	83	80	75	67
5	90	56	78	79	85	85	82	78	68
L_{WA} wylot [dB(A)]									
2	86	63	76	75	80	81	80	75	65
3	86	52	77	75	80	81	79	74	65
4	88	55	77	77	83	83	80	75	67
5	90	57	79	80	85	85	82	78	68
L_{WA} od obudowy [dB(A)]									
2	77	60	71	69	68	70	69	62	52
3	77	51	70	69	70	71	70	63	53
4	79	56	74	71	73	73	71	64	55
5	81	59	75	72	74	74	72	66	56

charakterystyki pracy

MBCK 560/13100T

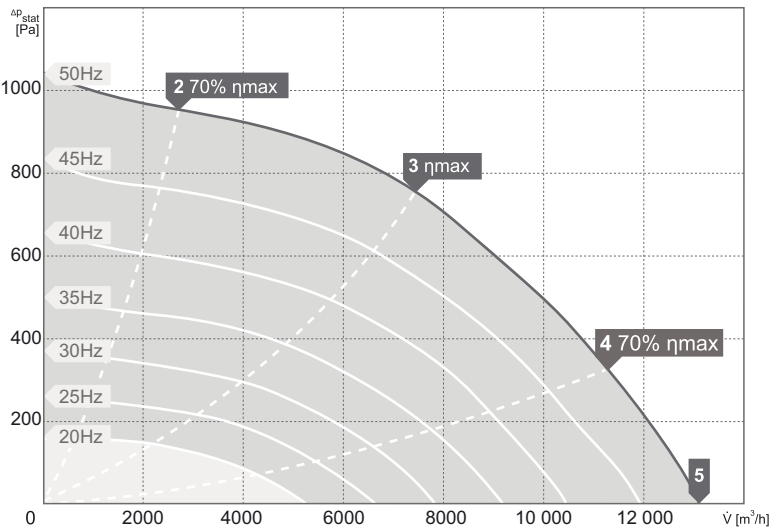

wartości mocy akustycznej L_{WA} [dB(A)]

dla poszczególnych częstotliwości pasm oktaowych [Hz]

Pkt. Pracy	tot	Częstotliwości pasm oktaowych [Hz]							
		63	125	250	500	1000	2000	4000	8000
L_{WA} wlot [dB(A)]									
2	84	60	74	74	76	78	77	72	65
3	85	52	77	77	77	79	79	74	67
4	90	54	83	83	82	82	82	78	70
5	91	55	83	84	82	83	84	80	71
L_{WA} wylot [dB(A)]									
2	88	64	77	77	82	83	80	75	67
3	88	49	77	78	82	83	81	77	68
4	91	54	80	82	86	86	83	79	70
5	93	56	84	84	87	88	85	83	71
L_{WA} od obudowy [dB(A)]									
2	75	59	70	67	68	68	62	58	50
3	76	47	66	65	72	73	63	58	50
4	78	51	73	69	73	71	64	60	51
5	79	54	75	71	71	70	66	63	53

MBCK 630/17500T

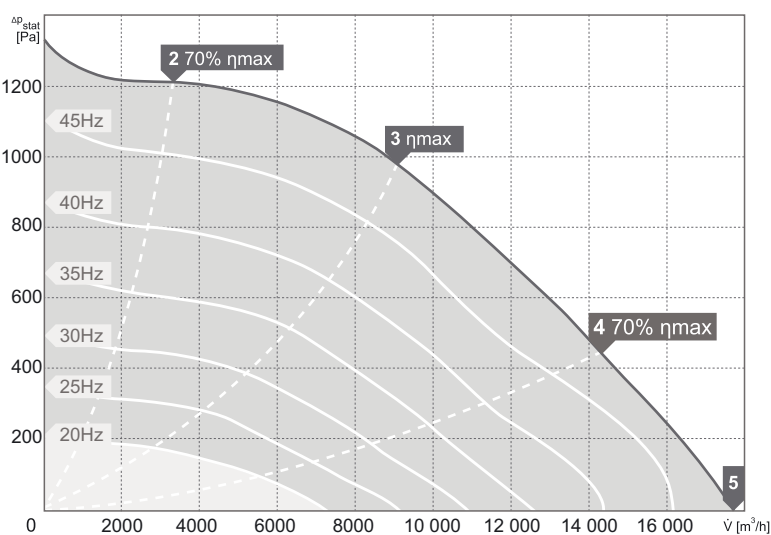

Pkt. Pracy	tot	Częstotliwości pasm oktaowych [Hz]							
		63	125	250	500	1000	2000	4000	8000
L_{WA} wlot [dB(A)]									
2	88	65	79	80	80	82	80	74	67
3	89	58	78	81	81	83	81	75	67
4	92	61	84	85	85	86	84	79	70
5	93	60	84	86	86	86	85	81	71
L_{WA} wylot [dB(A)]									
2	92	68	83	82	86	86	83	77	68
3	92	61	81	82	87	87	84	79	70
4	97	61	85	86	91	92	91	86	75
5	98	62	85	87	92	93	92	88	76
L_{WA} od obudowy [dB(A)]									
2	81	65	78	71	70	71	70	62	54
3	79	57	76	71	71	71	70	62	55
4	84	60	80	76	75	75	74	66	58
5	84	62	80	76	76	77	76	69	58

MBCK 710/19500T

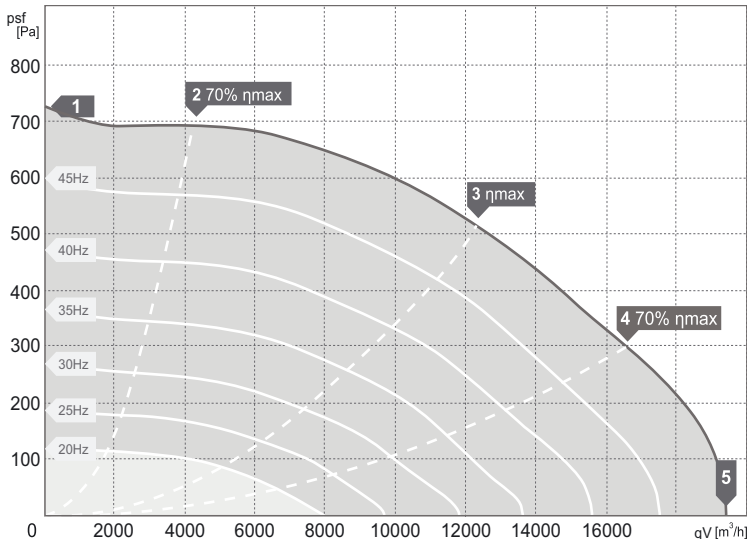

Pkt. Pracy	tot	Częstotliwości pasm oktaowych [Hz]							
		63	125	250	500	1000	2000	4000	8000
L_{WA} wlot [dB(A)]									
2	78	60	72	70	69	71	69	66	64
3	81	50	74	74	72	71	70	66	63
4	83	52	77	76	73	72	71	67	64
5	87	56	80	79	76	76	75	70	69
L_{WA} wylot [dB(A)]									
2	81	57	70	73	76	75	73	68	61
3	83	49	71	74	77	75	73	68	62
4	85	50	73	76	78	76	74	69	62
5	90	56	78	80	82	80	78	72	66
L_{WA} od obudowy [dB(A)]									
2	69	58	64	59	62	62	57	52	47
3	70	49	66	61	62	63	57	53	49
4	72	51	69	62	63	63	59	54	49
5	76	57	73	67	68	67	64	59	54

charakterystyki pracy

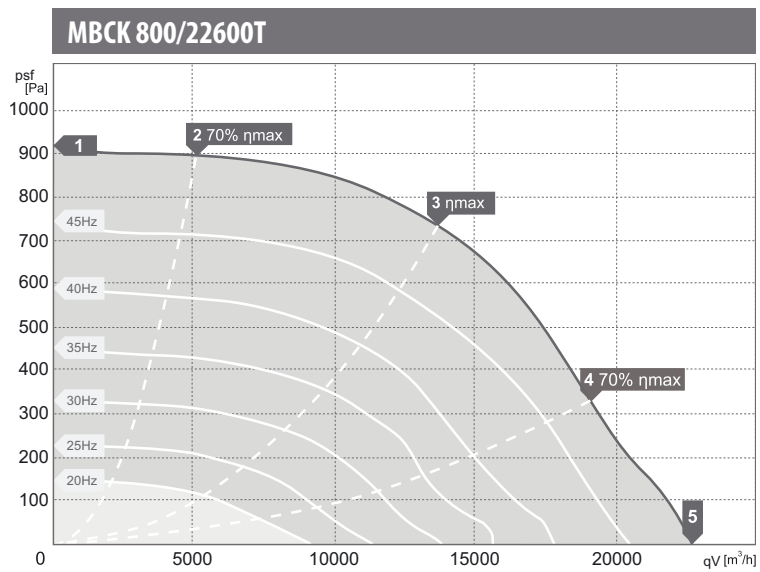

wartości mocy akustycznej L_{WA} [dB(A)]
dla poszczególnych częstotliwości pasm oktaowych [Hz]

Pkt. Pracy	Częstotliwości pasm oktaowych [Hz]								
	tot	63	125	250	500	1000	2000	4000	8000
L_{WA} wlot [dB(A)]									
2	86	63	73	76	77	81	80	74	68
3	87	58	74	76	77	81	81	75	68
4	88	56	80	80	78	82	81	74	67
5	89	57	81	81	79	83	81	75	68
L_{WA} wylot [dB(A)]									
2	89	65	73	80	83	84	83	76	65
3	90	55	73	79	83	85	85	78	67
4	92	59	79	83	87	86	84	77	68
5	93	60	80	84	87	87	85	78	68
L_{WA} od obudowy [dB(A)]									
2	77	61	68	71	69	73	68	60	53
3	78	56	67	70	70	74	69	61	53
4	80	59	73	72	72	75	70	62	54
5	81	61	74	74	73	77	71	63	56