



konstrukcja

Promieniowy wentylator kanałowy przeznaczony do zabudowy w systemie przewodów wentylacyjnych o przekroju prostokątnym. Obudowa wykonana z galwanizowanej blachy stalowej ma kształt sześcianu składającego się z ramy oraz paneli bocznych izolowanych warstwą wełny o grubości 30 mm (poza panelem wlotowym). W wykonaniu standardowym wlot stanowi wyprofilowany pierścień bez króćca przyłączeniowego. Wylot można skonfigurować względem wlotu pod kątem 90° lub w linii prostej, przez zmianę lokalizacji jednego z izolowanych paneli bocznych. Należy zwrócić szczególną uwagę na zachowanie prostych odcinków kanałów o jak największym przekroju.

wirnik

Wyważany dynamicznie wirnik typu B stanowi integralną część silnika (tzw. silnik z wirującą obudową). Łopatki pochylone do tyłu, dla wielkości 250 oraz 280 wirnik wykonany jest ze stali ocynkowanej, pozostałe modele posiadają wirniki z tworzywa.

napęd i sterowanie

Napęd stanowi nowoczesny silnik EC komutowany elektronicznie, zasilanie jedno lub trójfazowe (1~230V, 3~400V 50 Hz) ze zintegrowanym zabezpieczeniem termicznym. Stopień ochrony IP54, klasa izolacji F. Silniko-wirnik (silnik z wirującą obudową) został przystosowany do płynnej regulacji prędkości obrotowej w pełnym zakresie, przy zachowaniu wysokiej sprawności. Dostosowanie prędkości obrotowej wentylatora jest możliwe za pomocą potencjometru lub sygnału analogowego 0-10VDC

maksymalna temperatura pracy

50 ÷ 70°C - w zależności od wybranego modelu.

zastosowanie

Transport czystego, niezapyłonego powietrza w instalacjach wentylacyjnych do i z pomieszczeń w obiektach: mieszkalnych, biurowych, przemysłowych i użyteczności publicznej. MBC zalecany jest szczególnie do montażu w instalacjach o ograniczonej przestrzeni jak również w instalacjach o nietypowej zabudowie.

Akcesoria



AS
wyłącznik serwisowy



SENSOFLOW EC
regulator stałego ciśnienia



CTP 010/ MTP 10
potencjometr



USB
panel boczny



RCP
osłona dachowa



BAF
rama montażowa



WPH
osłona wlotu / wylotu



WPS
żaluzja na wlot



ASB
króciec wlotowy



USR
panel boczny na wylot z redukcją



FB
moduł filtracyjny



USP
panel boczny

tablica doboru akcesoriów dla danego wentylatora MBC EC

Typ MBC EC	225/1000EC	250/1500EC	280/2000EC	355/3000EC
Żaluzja na wylot	WPS 01	WPS 01	WPS 01	WPS 02
Panel boczny	USR 01/02	USR 01/02	USR 01/02	USR 04/05/06
Króciec wlotowy	ASB 01/02/03	ASB 01/02/03	ASB 01/02/03	ASB 04/05/06
Wyłącznik serwisowy	AS 16A 4P	AS 16A 4P	AS 16A 4P	AS 16A 4P
Potencjometr	CTP 010/MTP 10	CTP 010/MTP 10	CTP 010/MTP 10	CTP 010/MTP 10
Regulator stałego ciśnienia	SENSOFLOW EC	SENSOFLOW EC	SENSOFLOW EC	SENSOFLOW EC
Panel boczny na wylot	USB 01/02	USB 02	USB 01/02	USB 03/04/05
osłona wlotu/wylotu	WPH 01	WPH 01	WPH 01	WPH 02
osłona dachowa	RCP 01	RCP 01	RCP 01	RCP 02
Rama montażowa	BAF 01	BAF 01	BAF 01	BAF 02
Moduł filtracyjny	FB 500	FB 500	FB 500	FB 700
Panel boczny	USP 500	USP 500	USP 500	USP 500

Typ MBC EC	400/5600EC	450/6200EC	450/7000EC	500/9800TEC	560/15500TEC	630/17700TEC
Żaluzja na wylot	WPS 02	WPS 02	WPS 02	WPS 02	WPS 03	WPS 03
Panel boczny	USR 04/05/06	USR 04/05/06	USR 04/05/06	USR 04/05/06	USR 07/08	USR 07/08
Króciec wlotowy	ASB 03/04/05/06	ASB 04/05/06	ASB 04/05/06	ASB 04/05/06	ASB 06/07/08	ASB 07/08
wyłącznik serwisowy	AS 16A 4P	AS 16A 4P	AS 16A 4P	AS 16A 4P	AS 32A 4P	AS 16A 4P
Potencjometr	CTP 010/MTP 10	CTP 010/MTP 10	CTP 010/MTP 10	CTP 010/MTP 10	CTP 010/MTP 10	CTP 010/MTP 10
Regulator stałego ciśnienia	SENSOFLOW EC	SENSOFLOW EC	SENSOFLOW EC	SENSOFLOW EC	SENSOFLOW EC	SENSOFLOW EC
Panel boczny na wylot	USB 03/04/05	USB 04/05	USB 04/05	USB 04/05	USB 06/07/08	USB 06/07/08
osłona wlotu/wylotu	WPH 02	WPH 02	WPH 02	WPH 02	WPH 03	WPH 03
osłona dachowa	RCP 02	RCP 02	RCP 02	RCP 02	RCP 03	RCP 03
Rama montażowa	BAF 02	BAF 02	BAF 02	BAF 02	BAF 03	BAF 03
Moduł filtracyjny	FB 700	FB 700	FB 700	FB 900	FB 900	FB 900
Panel boczny	USP 700	USP 700	USP 700	USP 700	USP 900	USP 900

dane techniczne

Typ	\dot{V}_{\max} [m ³ /h]	Δp_{\max} [Pa]	P_{\max} [W]	U_n/U_{ster} [V]	I_{\max} [A]	RPM_{\max} [1/min]	L_{WA} [dB(A)]	L_{pA} [dB(A)]	t_{\max} [°C]	m	nr katalogowy
MBC 225/1000EC	1030	540	116	230, 1~/0-10	1	2920	51	44	60	27,7	15795300
MBC 250/1500EC	1520	680	207	230, 1~/0-10	1,8	2995	65	58	70	28,9	15795400
MBC 280/2000EC	2030	790	270	230, 1~/0-10	1,9	2900	69	62	55	29,1	15795500
MBC 355/3000EC	3080	390	164	230, 1~/0-10	1,4	1485	46	59	60	49,4	15980200
MBC 400/5600EC	5680	860	529	230, 1~/0-10	2,4	1935	55	48	50	62,0	15795600
MBC 450/6200EC	6270	600	527	230, 1~/0-10	2,4	1510	54	47	50	65,0	15796000
MBC 450/7000EC	6970	655	860	230, 1~/0-10	3,9	1500	63	56	40	51,6	16410100
MBC 500/9800TEC	9830	1040	1343	400, 3~/0-10	2,1	1600	58	51	50	56,2	15791600
MBC 560/15500TEC	15560	1225	3530	400, 3~/0-10	5,4	1790	65	58	60	101,2	15796100
MBC 630/17700TEC	17720	820	2733	400, 3~/0-10	4,3	1300	64	57	40	98	15732500

wymiary

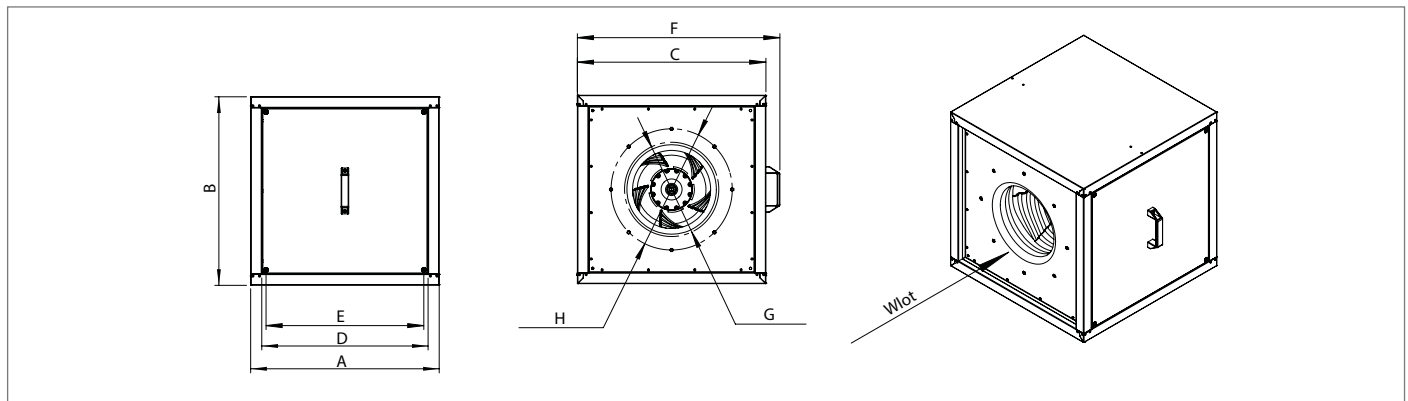

Typ	A [mm]	B [mm]	C [mm]	D [mm]	E [mm]	F [mm]	G [mm]	H [mm]
MBC 225/1000EC	500	500	500	417	386	552	195	6xM6 LK Ø250
MBC 250/1500EC	500	500	500	417	386	552	220	6xM6 LK Ø250
MBC 280/2000EC	500	500	500	417	386	552	240	6xM6 LK Ø280
MBC 355/3000EC	700	700	700	617	586	752	315	8xM8 LK Ø355
MBC 400/5600EC	700	700	700	617	586	752	340	8xM8 LK Ø395
MBC 450/6200EC	700	700	700	617	586	752	350	12xM6 LK Ø395
MBC 450/7000EC	700	700	700	617	586	752	350	8xM8 LK Ø450
MBC 500/9800TEC	700	700	700	617	586	752	430	8xM8 LK Ø500
MBC 560/15500TEC	900	900	900	817	786	952	500	12xM8 LK Ø560
MBC 630/17700TEC	900	900	900	817	786	952	550	12xM8 LK Ø620

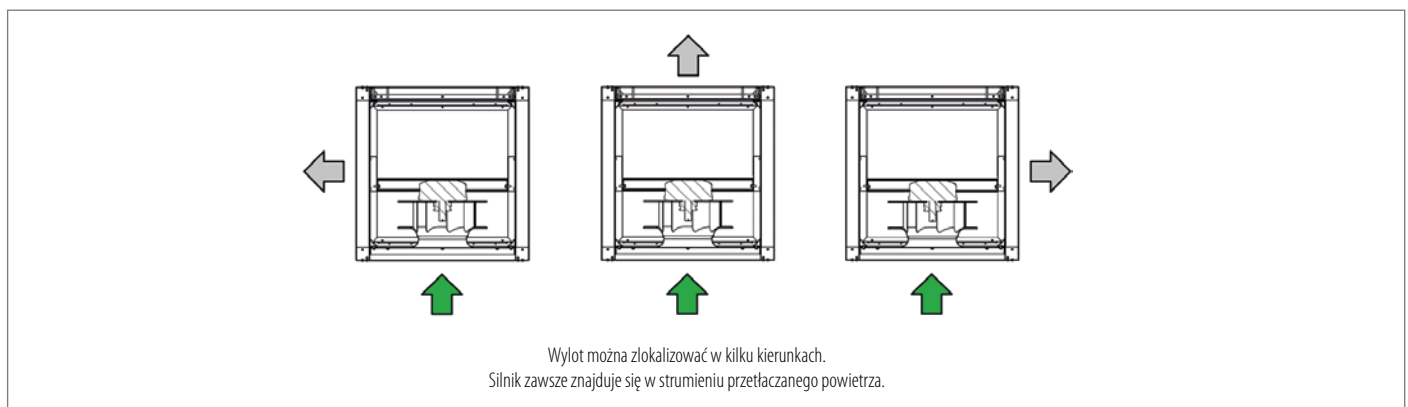

schematy podłączenia elektrycznego

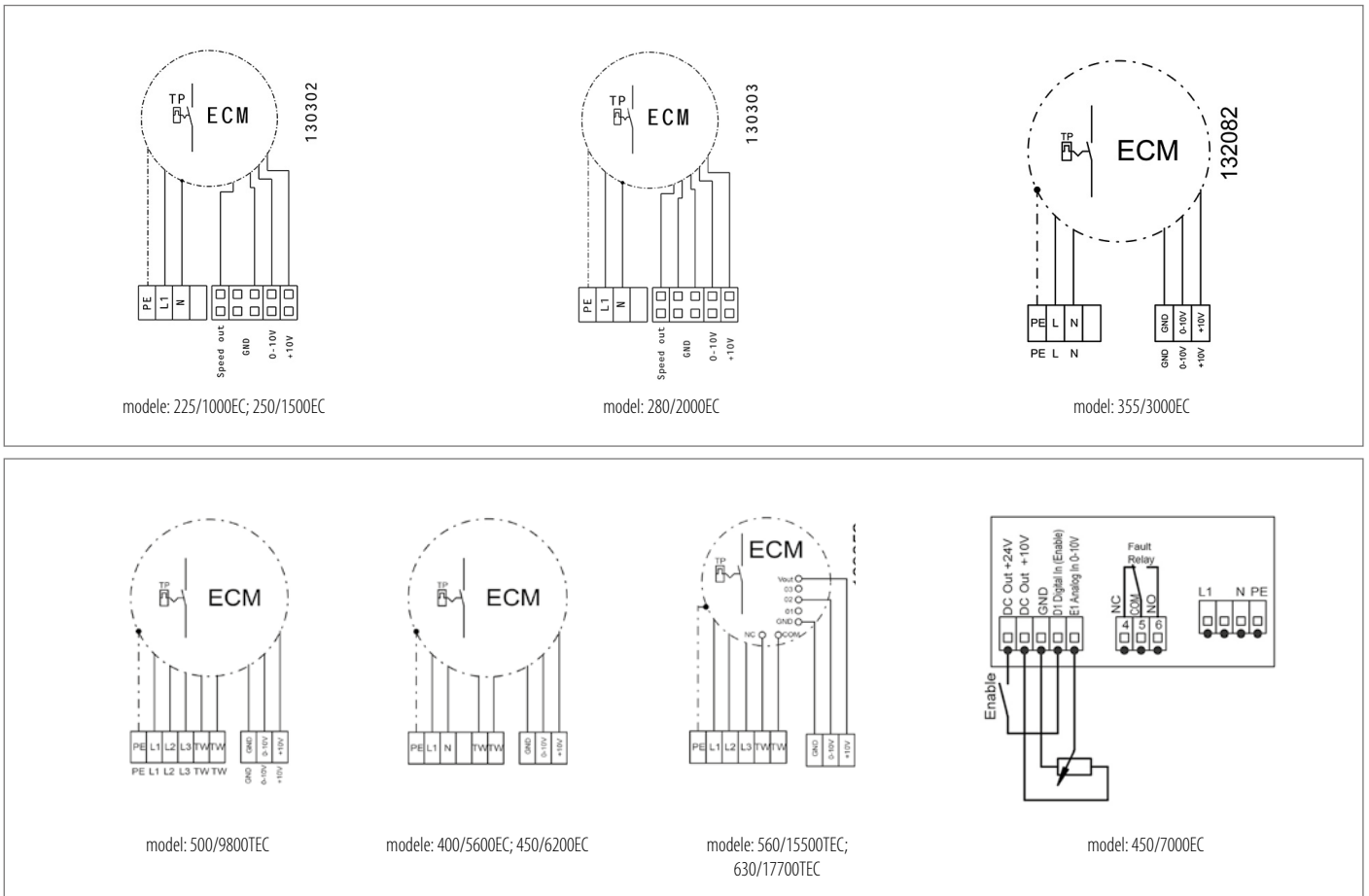

charakterystyki pracy

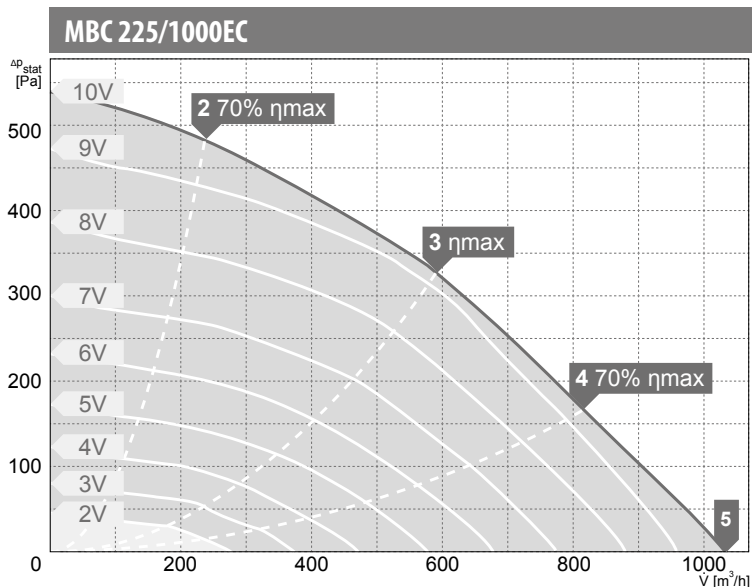

wartości mocy akustycznej L_{WA} [dB(A)]
dla poszczególnych częstotliwości pasm oktaowych [Hz]

Pkt. Pracy	Częstotliwości pasm oktaowych [Hz]								
	tot	63	125	250	500	1000	2000	4000	8000
L_{WA} wlot [dB(A)]									
2	73	42	58	66	68	67	64	58	51
3	67	37	49	61	61	62	59	56	47
4	72	37	46	61	64	66	66	64	56
5	75	36	48	63	66	70	70	66	62
L_{WA} wylot [dB(A)]									
2	74	45	64	64	68	68	69	61	52
3	69	42	53	60	62	63	64	60	49
4	75	37	50	61	65	68	71	68	59
5	78	37	52	64	67	72	74	71	65
L_{WA} od obudowy [dB(A)]									
2	57	44	52	46	46	45	50	48	46
3	51	39	43	41	43	42	45	42	39
4	49	39	42	41	42	38	43	40	32
5	52	38	43	44	43	42	46	44	39

charakterystyki pracy

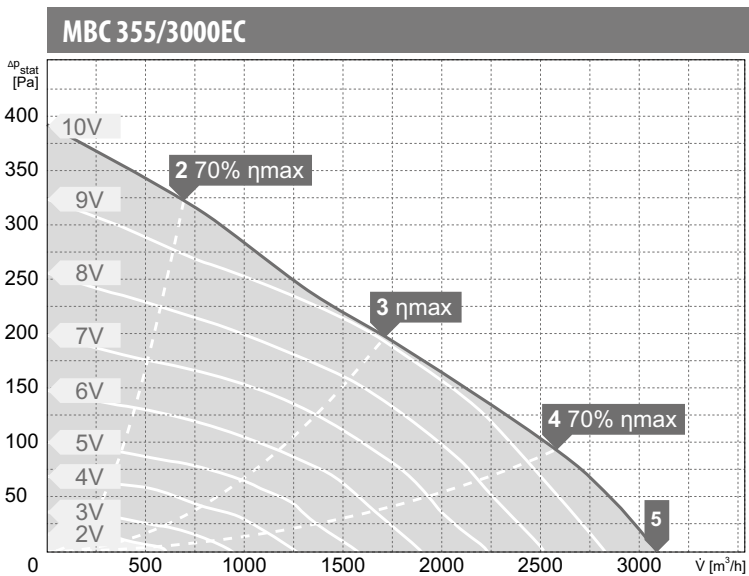
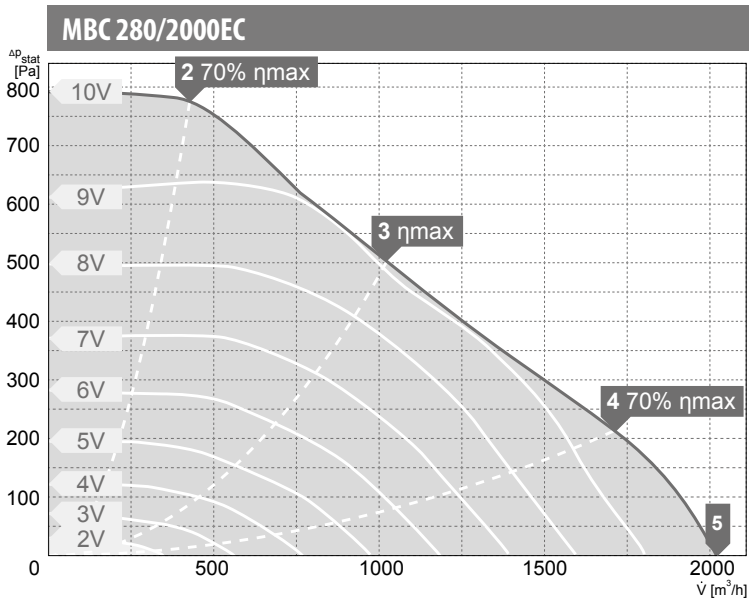
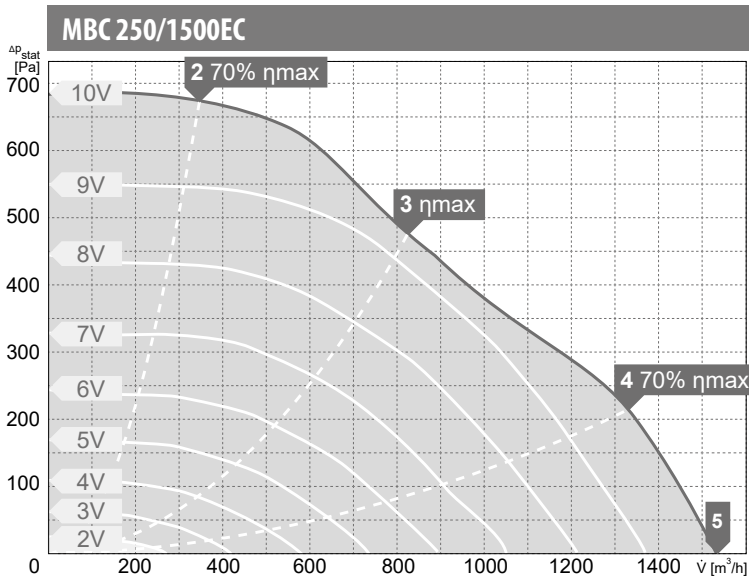

wartości mocy akustycznej L_{WA} [dB(A)]
dla poszczególnych częstotliwości pasm oktaowych [Hz]

Pkt. Pracy	tot	Częstotliwości pasm oktaowych [Hz]							
		63	125	250	500	1000	2000	4000	8000
L_{WA} wlot [dB(A)]									
2	78	49	59	71	73	73	67	67	63
3	77	42	53	70	71	72	66	67	63
4	82	42	55	73	77	77	72	71	67
5	84	45	58	74	78	79	74	73	69
L_{WA} wylot [dB(A)]									
2	79	51	62	68	72	73	73	70	64
3	79	46	56	67	72	74	73	69	64
4	83	45	57	72	76	78	78	74	69
5	86	50	60	73	78	80	81	76	71
L_{WA} od obudowy [dB(A)]									
2	62	52	51	51	50	58	51	52	50
3	65	42	43	49	46	65	49	47	44
4	60	44	46	51	49	57	51	47	42
5	61	47	48	53	52	56	52	49	44

Pkt. Pracy	tot	Częstotliwości pasm oktaowych [Hz]							
		63	125	250	500	1000	2000	4000	8000
L_{WA} wlot [dB(A)]									
2	83	50	63	73	79	79	70	70	67
3	76	36	48	66	70	70	67	68	66
4	80	38	50	70	75	74	71	71	68
5	83	39	52	73	77	77	74	73	72
LWA wylot [dB(A)]									
2	83	54	67	72	79	77	76	72	68
3	78	37	50	67	71	74	72	69	66
4	84	41	54	72	78	78	77	73	70
5	85	42	56	74	79	79	79	75	73
L_{WA} od obudowy [dB(A)]									
2	66	55	52	55	53	62	54	54	53
3	69	39	41	48	52	69	51	50	47
4	63	40	42	50	47	63	49	46	42
5	61	44	44	51	48	59	51	48	46

Pkt. Pracy	tot	Częstotliwości pasm oktaowych [Hz]							
		63	125	250	500	1000	2000	4000	8000
L_{WA} wlot [dB(A)]									
2	66	44	57	59	61	60	58	53	45
3	63	30	51	55	58	56	56	54	42
4	71	34	58	61	65	63	61	66	56
5	73	35	58	63	67	65	63	67	63
L_{WA} wylot [dB(A)]									
2	71	51	66	61	62	64	61	56	44
3	67	31	55	56	60	63	59	59	45
4	73	38	62	62	66	68	64	66	56
5	76	41	61	67	68	71	67	68	62
L_{WA} od obudowy [dB(A)]									
2	57	44	56	43	42	40	39	37	37
3	46	30	43	39	39	35	34	32	27
4	50	30	47	43	41	39	36	35	25
5	54	35	49	49	46	42	39	37	33

charakterystyki pracy

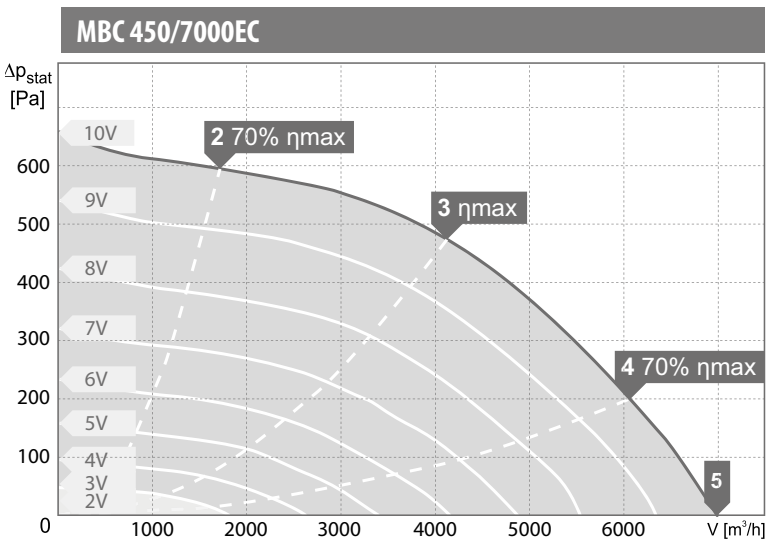
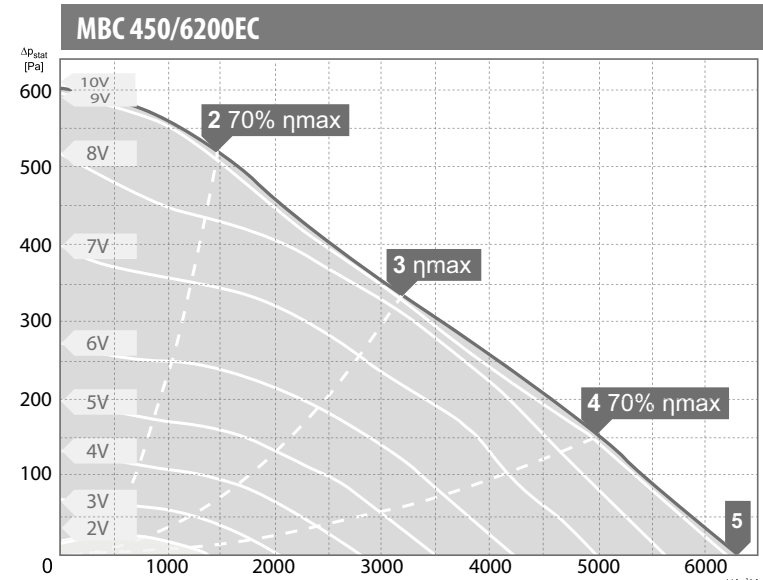
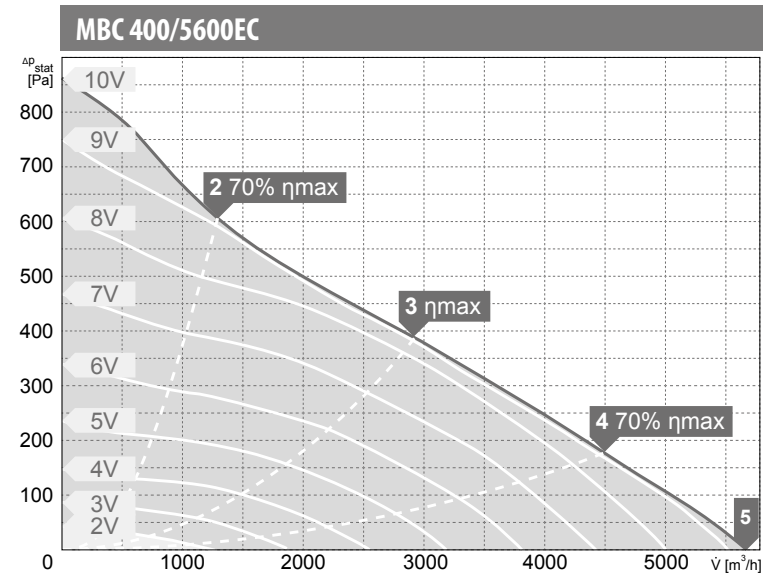

wartości mocy akustycznej L_{WA} [dB(A)]
dla poszczególnych częstotliwości pasm oktaowych [Hz]

Pkt. Pracy	Częstotliwości pasm oktaowych [Hz]								
	tot	63	125	250	500	1000	2000	4000	8000
L_{WA} wlot [dB(A)]									
2	77	53	71	70	71	70	68	64	55
3	73	38	63	62	65	66	68	60	51
4	77	40	65	67	71	70	70	67	62
5	82	44	71	73	76	74	74	72	67
LWA wylot [dB(A)]									
2	80	57	73	70	73	75	71	65	56
3	76	40	66	68	69	71	68	62	53
4	81	45	72	72	75	77	73	68	64
5	86	49	77	77	79	81	77	73	67
L_{WA} od obudowy [dB(A)]									
2	64	53	60	57	47	49	51	52	51
3	55	39	49	48	42	44	46	46	42
4	55	40	52	50	45	45	45	41	33
5	60	43	57	54	50	49	49	44	37

Pkt. Pracy	Częstotliwości pasm oktaowych [Hz]								
	tot	63	125	250	500	1000	2000	4000	8000
L_{WA} wlot [dB(A)]									
2	77	54	68	70	73	69	69	63	54
3	71	40	57	62	66	63	64	61	51
4	78	47	65	67	72	70	71	67	71
5	83	48	74	70	75	73	75	65	78
LWA wylot [dB(A)]									
2	80	56	70	71	74	76	72	66	56
3	75	44	62	65	69	70	67	63	52
4	82	49	71	71	75	78	76	68	71
5	87	51	77	76	79	82	80	69	77
L_{WA} od obudowy [dB(A)]									
2	62	53	56	57	49	48	49	49	46
3	54	39	48	50	44	43	44	43	39
4	58	43	53	54	47	44	43	40	43
5	61	47	56	56	49	48	48	39	47

Pkt. Pracy	Częstotliwości pasm oktaowych [Hz]								
	tot	63	125	250	500	1000	2000	4000	8000
L_{WA} wlot [dB(A)]									
2	75	53	63	67	70	68	65	61	55
3	74	43	61	66	69	68	65	60	55
4	79	46	64	69	74	75	71	65	62
5	81	48	65	70	76	77	74	67	65
LWA wylot [dB(A)]									
2	81	60	77	72	75	74	70	64	57
3	81	49	78	69	74	74	70	65	58
4	84	51	78	70	78	79	75	68	63
5	86	54	80	73	80	81	78	70	66
L_{WA} od obudowy [dB(A)]									
2	63	52	61	51	47	45	43	42	35
3	63	43	63	49	46	45	43	40	34
4	63	46	62	51	50	48	47	38	31
5	64	48	63	53	51	50	49	39	33

charakterystyki pracy

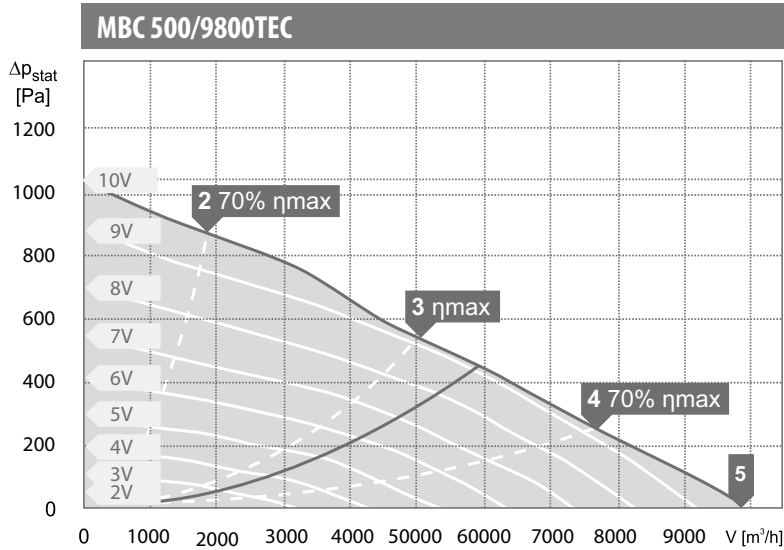

wartości mocy akustycznej L_{WA} [dB(A)]
dla poszczególnych częstotliwości pasm oktaowych [Hz]

Pkt. Pracy	Częstotliwości pasm oktaowych [Hz]								
	tot	63	125	250	500	1000	2000	4000	8000
L_{WA} wlot [dB(A)]									
2	81	55	70	73	76	74	73	70	64
3	77	47	65	69	71	69	69	66	61
4	77	50	67	68	71	71	70	67	63
5	80	53	70	71	74	74	73	70	69
L_{WA} wylot [dB(A)]									
2	85	61	77	76	80	79	74	69	62
3	81	49	74	71	76	74	70	65	59
4	83	52	75	73	78	77	74	68	65
5	87	56	77	77	82	81	78	73	72
L_{WA} od obudowy [dB(A)]									
2	68	58	66	59	54	54	56	54	48
3	63	47	61	52	51	51	52	49	44
4	64	48	62	53	51	51	51	46	39
5	67	52	65	57	54	54	53	45	41

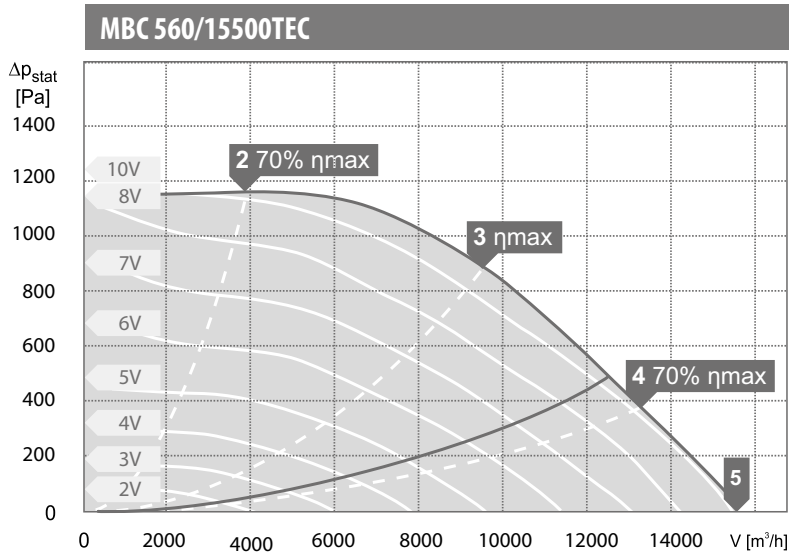

Pkt. Pracy	Częstotliwości pasm oktaowych [Hz]								
	tot	63	125	250	500	1000	2000	4000	8000
L_{WA} wlot [dB(A)]									
2	89	63	80	82	84	82	79	73	70
3	88	50	79	81	83	80	77	73	72
4	91	54	80	84	86	83	80	75	80
5	92	55	82	85	87	84	81	78	81
L_{WA} wylot [dB(A)]									
2	91	67	77	82	86	87	83	76	67
3	89	55	77	80	83	85	81	75	71
4	92	60	79	82	86	87	82	77	79
5	93	60	82	84	87	88	84	81	81
L_{WA} od obudowy [dB(A)]									
2	73	65	69	64	59	61	62	56	47
3	70	50	68	64	55	59	57	51	47
4	71	51	69	66	57	58	56	50	51
5	73	53	71	68	58	58	58	52	53

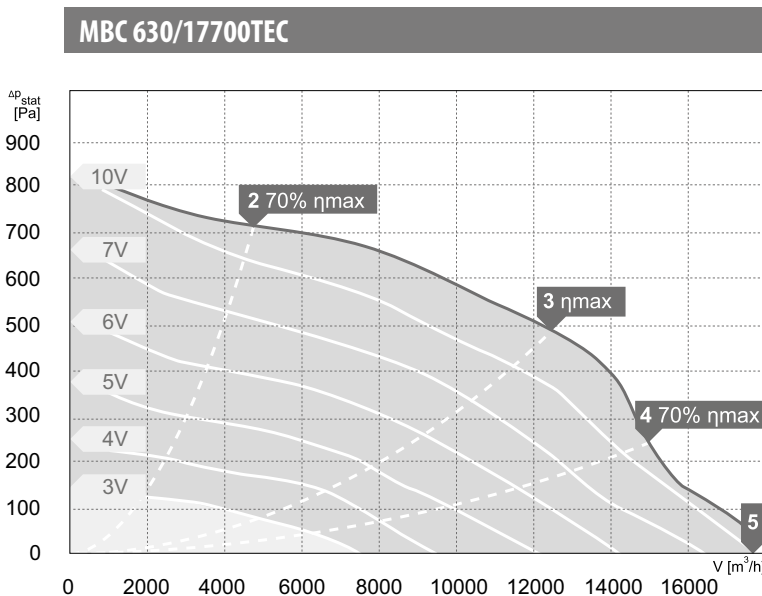

Pkt. Pracy	Częstotliwości pasm oktaowych [Hz]								
	tot	63	125	250	500	1000	2000	4000	8000
L_{WA} wlot [dB(A)]									
2	85	62	75	79	79	77	74	70	66
3	82	49	73	77	76	74	71	68	62
4	84	51	75	78	78	76	75	71	62
5	85	52	76	79	79	76	76	73	62
L_{WA} wylot [dB(A)]									
2	88	69	77	80	82	82	77	71	62
3	84	52	71	75	79	79	75	70	60
4	86	54	75	77	81	80	77	73	62
5	88	56	77	78	82	81	78	75	63
L_{WA} od obudowy [dB(A)]									
2	70	66	66	61	55	55	57	55	49
3	66	46	64	56	53	52	54	52	46
4	68	48	66	58	55	54	55	53	44
5	71	50	70	60	57	55	56	53	44