



konstrukcja

Wentylator diagonalny średniego ciśnienia oferujący wysoką sprawność aerodynamiczną przy niskim zużyciu energii. Zastosowany profil wirnika, przypominający kształtem wirnik diagonalny, gwarantuje większą wydajność oraz znacznie wyższe sprężenie, w porównaniu do tradycyjnych wentylatorów osiowych. Stalowa spawana obudowa o zoptymalizowanej masie, umożliwia montaż zarówno w pionie jak i w poziomie. Kołnierz z otworami montażowymi zgodnymi ze standardem EUROVENT 1/2. Powierzchnia malowana proszkowo w kolorze RAL 7012 zapewnia klasę korozyjności C3 zgodnie z normą PN-EN ISO 12944-2.

wirnik

Wyważony dynamicznie wirnik diagonalny z sześcioma trójwymiarowymi łopatkami ze stożkową piastą w solidnej spawanej konstrukcji. Wykonany ze stali malowanej proszkowo, gwarantujący kategorię korozyjności C3 zgodnie z normą DIN EN ISO 12944-2. Wyważony zgodnie z DIN ISO 1940 w klasie wyważenia G6.3.

napęd i sterowanie

Napęd stanowią trójfazowe (400V, 50Hz) asynchroniczne silniki elektryczne o klasie sprawności IE3, stopniu ochrony IP55 i klasie izolacji F. Prędkość obrotowa może być kontrolowana za pomocą przemienników częstotliwości, wyłącznie w zakresie częstotliwości (obrotów) podanych w tabeli/wykresie doboru. Zalecany czas przyspieszania i hamowania przetwornicą (rampa): 20-30 sek. W przypadku bezpośredniego podłączenia do sieci obowiązuje charakterystyka dla 50Hz. Silniki należy zabezpieczyć za pomocą wyłączników z wbudowanym wyłącznikiem zwarciowym i przeciążeniowym. Podłączenie elektryczne bezpośrednio do wbudowanej puszkii przyłączeniowej lub wyłącznika serwisowego (do zakupu oddzielnie).

maksymalna temperatura pracy

60°C

zastosowanie

Transport czystego, niezapylnego powietrza w instalacjach wentylacyjnych do i z pomieszczeń w obiektach: mieszkalnych, biurowych, przemysłowych i użyteczności publicznej.

Akcesoria



tablica doboru akcesoriów

TYP MAXEE	MAXEE 315/4/3900T	MAXEE 315/2/5800T	MAXEE 355/4/4800T	MAXEE 355/2/6900T	MAXEE 400/4/6800T	MAXEE 400/2/10800T	MAXEE 450/4/8400T	MAXEE 450/2/15300T
Wyłącznik serwisowy	AS 16A 4P	AS 16A 4P	AS 16A 4P	AS 16A 4P	AS 16A 4P	AS 16A 4P	AS 16A 4P	AS 32A 4P
Przebiegnik częstotliwości	LV0004G100-4E0FN	LV0008G100-4E0FN	LV0004G100-4E0FN	LV0008G100-4E0FN	LV0008G100-4E0FN	LV0022G100-4E0FN	LV0008G100-4E0FN	LV0040G100-4E0FN2
Wyłącznik silnikowy	1-1,6A	2,5-4A	1-1,6A	2,5-4A	2,5-4A	4-6,3A	2,5-4A	6,3-10A
Stopa montażowa	FAL 315	FAL 315	FAL 355	FAL 355	FAL 400	FAL 400	FAL 450	FAL 450
Kołnierz wlotowy	RAF 315	RAF 315	RAF 355	RAF 355	RAF 400	RAF 400	RAF 450	RAF 450
Złącze przeciwdrganie	EXP 315	EXP 315	EXP 355	EXP 355	EXP 400	EXP 400	EXP 450	EXP 450
Króciec wlotowy	ESD 315	ESD 315	ESD 350	ESD 350	ESD 400	ESD 400	ESD 450	ESD 450
Kłapa zwrotna pozioma	RVK H 315	RVK H 315	RVK H 355	RVK H 355	RVK H 400	RVK H 400	RVK H 450	RVK H 450
Kłapa zwrotna pionowa	RVK 315	RVK 315	RVK 355	RVK 355	RVK 400	RVK 400	RVK 450	RVK 450
Przylącze okrągłe	RVS 315	RVS 315	RVS 355	RVS 355	RVS 400	RVS 400	RVS 450	RVS 450
Siatka ochronna	SGW 315/355 SGE 315	SGW 315/355 SGE 315	SGW 355/400 SGE 355	SGW 355/400 SGE 355	SGW 400/450 SGE 400	SGW 400/450 SGE 400	SGW 450/500 SGE 450	SGW 450/500 SGE 450
Wibroizolator gumowy	FSD 05	FSD 05	FSD 05	FSD 05	FSD 05	FSD 05	FSD 05	FSD 06
Wibroizolator sprężynowy	FSD 01	FSD 01	FSD 01	FSD 01	FSD 01	FSD 02	FSD 02	FSD 03
Pierścieni montażowy	MR 315	MR 315	MR 355	MR 355	MR 400	MR 400	MR 450	MR 450

tablica doboru akcesoriów

TYP MAXEE	MAXEE 500/4/11600T	MAXEE 500/2/19600T	MAXEE 560/4/15300T	MAXEE 560/4/16500T	MAXEE 630/4/24600T	MAXEE 630/6/16100T	MAXEE 710/6/22500T	MAXEE 710/4/36500T
Wyłącznik serwisowy	AS 16A 4P	AS 32A 4P	AS 16A 4P	AS 16A 4P	AS 32A 4P	AS 16A 4P	AS 16A 4P	AS 32A 4P
Przebiegnik częstotliwości	LV0015G100-4E0FN	LV0055G100-4E0FN	LV0015G100-4E0FN	LV0022G100-4E0FN	LV0055G100-4E0FN	LV0015G100-4E0FN	LV0022G100-4E0FN	LV0075G100-4E0FN2
Wyłącznik silnikowy	2,5-4A	9-13A	2,5-4A	4-6,3A	6,3-10 A	2,5-4 A	4-6,3 A	11-17A
Stopa montażowa	FAL 500	FAL 500	FAL 560	FAL 560	FAL 630	FAL 630	FAL 710	FAL 710
Kołnierz wlotowy	RAF 500	RAF 500	RAF 560	RAF 560	RAF 630	RAF 630	RAF 710	RAF 710
Złącze przeciwdrganiowe	EXP 500	EXP 500	EXP 560	EXP 560	EXP 630	EXP 630	EXP 710	EXP 710
Króciec wlotowy	ESD 500	ESD 500	ESD 560	ESD 560	ESD 630	ESD 630	ESD 710	ESD 710
Kłapa zwrotna pozioma	RVK H 500	RVK H 500	RVK H 560	RVK H 560	RVK H 630	RVK H 630	RVK H 710	RVK H 710
Kłapa zwrotna pionowa	RVK 500	RVK 500	RVK 560	RVK 560	RVK 630	RVK 630	RVK 710	RVK 710
Przylącze okrągłe	RVS 500	RVS 500	RVS 560	RVS 560	RVS 630	RVS 630	RVS 710	RVS 710
Siatka ochronna	SGW 500/560 SGE 500	SGW 500/560 SGE 500	SGW 560/630 SGE 560	SGW 560/630 SGE 560	SGW 630/710 SGE 630	SGW 630/710 SGE 630	SGW 710/800 SGE 710	SGW 710/800 SGE 710
Wibroizolator gumowy	FSD 05	FSD 06	FSD 06	FSD 06	FSD 06	FSD 06	FSD 07	FSD 07
Wibroizolator sprężynowy	FSD 02	FSD 04	FSD 02	FSD 02	FSD 03	FSD 02	FSD 04	FSD 04
Pierścień montażowy	MR 500	MR 500	MR 560	MR 560	MR 630	MR 630	MR 710	MR 710

TYP MAXEE	MAXEE 800/6/26500T	MAXEE 800/4/30800T	MAXEE 800/4/31600T	MAXEE 800/6/36800T	MAXEE 800/4/39900T	MAXEE 800/4/48700T	MAXEE 900/4/43300T	MAXEE 900/6/43400T
Wyłącznik serwisowy	AS 32A 4P	AS 32A 4P	AS 32A 4P	AS 32A 4P	AS 32A 4P	AS 32A 4P	AS 32A 4P	AS 32A 4P
Przebiegnik częstotliwości	LV0022G100-4E0FN	LV0055G100-4E0FN ***	LV0055G100-4E0FN ***	LV0055G100-4E0FN	LV0075G100-4E0FN	LV0110G100-4E0FN	LV0075G100-4E0FN ***	LV0075G100-4E0FN
Wyłącznik silnikowy	4-6,3 A	6,3-10 A	-	-	-	-	-	-
Stopa montażowa	FAL 800	FAL 800	FAL 800	FAL 800	FAL 800	FAL 800	FAL 900	FAL 900
Kołnierz wlotowy	RAF 800	RAF 800	RAF 800	RAF 800	RAF 800	RAF 800	RAF 900	RAF 900
Złącze przeciwdrganiowe	EXP 800	EXP 800	EXP 800	EXP 800	EXP 800	EXP 800	EXP 900	EXP 900
Króciec wlotowy	ESD 800	ESD 800	ESD 800	ESD 800	ESD 800	ESD 800	ESD 900	ESD 900
Kłapa zwrotna pozioma	RVK H 800	RVK H 800	RVK H 800	RVK H 800	RVK H 800	RVK H 800	RVK H 900	RVK H 900
Kłapa zwrotna pionowa	RVK 800	RVK 800	RVK 800	RVK 800	RVK 800	RVK 800	RVK 900	RVK 900
Przylącze okrągłe	RVS 800	RVS 800	RVS 800	RVS 800	RVS 800	RVS 800	RVS 900	RVS 900
Siatka ochronna	SGW 800/900 SGE 800	SGW 800/900 SGE 800	SGW 800/900 SGE 800	SGW 800/900 SGE 800	SGW 800/900 SGE 800	SGW 800/900 SGE 800	SGW 900/1000 SGE 900	SGW 900/1000 SGE 900
Wibroizolator gumowy	FSD 08	FSD 08	FSD 08	FSD 08	FSD 08	FSD 08	FSD 08	FSD 08
Wibroizolator sprężynowy	FSD 10	FSD 10	FSD 10	FSD 10	FSD 10	FSD 10	FSD 10	FSD 10
Pierścień montażowy	MR 800	MR 800	MR 800	MR 800	MR 800	MR 800	MR 900	MR 900

tablica doboru akcesoriów

TYP MAXEE	MAXEE 900/4/49400T	MAXEE 900/4/54700T	MAXEE 900/4/60300T	MAXEE 1000/6/49300T*	MAXEE 1000/4/60000T*	MAXEE 1000/6/60100T*	MAXEE 1000/4/67500T*	MAXEE 1000/4/75800T*
Wyłącznik serwisowy	AS 32A 4P	AS 50A 4P	AS 50A 4P	AS 32A 4P	AS 50A 4P	AS 50A 4P	AS 50A 4P	-
Przebiegnik częstotliwości	LV0110G100-4E0FN***	LV0150G100-4E0FN	LV0150G100-4E0FN	LV0075G100-4E0FN	LV0150G100-4E0FN***	LV0110G100-4E0FN	LV0185G100-4E0FN***	LV0220G100-4E0FN
Wyłącznik silnikowy	-	-	-	-	-	-	-	-
Stopa montażowa	FAL 900	FAL 900	FAL 900	FAL 1000**	FAL 1000**	FAL 1000**	FAL 1000**	FAL 1000**
Kołnierż wlotowy	RAF 900	RAF 900	RAF 900	RAF 1000	RAF 1000	RAF 1000	RAF 1000	RAF 1000
Złącze przeciwdrganiewe	EXP 900	EXP 900	EXP 900	EXP 1000	EXP 1000	EXP 1000	EXP 1000	EXP 1000
Króciec wlotowy	ESD 900	ESD 900	ESD 900	ESD 1000	ESD 1000	ESD 1000	ESD 1000	ESD 1000
Kłapa zwrotna pozioma	RVK H 900	RVK H 900	RVK H 900	RVK H 1000	RVK H 1000	RVK H 1000	RVK H 1000	RVK H 1000
Kłapa zwrotna pionowa	RVK 900	RVK 900	RVK 900	RVK 1000	RVK 1000	RVK 1000	RVK 1000	RVK 1000
Przylączka okrągłe	RVS 900	RVS 900	RVS 900	RVS 1000	RVS 1000	RVS 1000	RVS 1000	RVS 1000
Siatka ochronna	SGW 900/1000 SGE 900	SGW 900/1000 SGE 900	SGW 900/1000 SGE 900	SGW 1000/1120 SGE 1000	SGW 1000/1120 SGE 1000	SGW 1000/1120 SGE 1000	SGW 1000/1120 SGE 1000	SGW 1000/1120 SGE 1000
Wibroizolator gumowy	FSD 08	FSD 08	FSD 08	FSD 08	FSD 08	FSD 08	FSD 08	FSD 08
Wibroizolator sprężynowy	FSD 10	FSD 10	FSD 10	FSD 10	FSD 10	FSD 11	FSD 11	FSD 11
Belka poprzeczna	-	-	-	TRA 1000	TRA 1000	TRA 1000	TRA 1000	TRA 1000
Pierścień montażowy	MR 900	MR 900	MR 900	MR 1000	MR 1000	MR 1000	MR 1000	MR 1000

TYP MAXEE	MAXEE 1000/4/76100T*	MAXEE 1120/6/62200*	MAXEE 1120/6/71400T*	MAXEE 1120/6/85800T*	MAXEE 1250/6/79400T*	MAXEE 1250/6/98500T*	MAXEE 1250/6/109300T*	MAXEE 1250/6/119600T*
Wyłącznik serwisowy	-	AS 32A 4P	AS 50A 4P	-	AS 50A 4P	-	-	-
Przebiegnik częstotliwości	LV0220G100-4E0FN	LV0075G100-4E0FN***	LV0110G100-4E0FN	LV0185G100-4E0FN	LV0150G100-4E0FN***	LV0220G100-4E0FN	LVL0300S100-4COFDS	LVL0370 S100-4COFDS
Wyłącznik silnikowy	-	-	-	-	-	-	-	-
Stopa montażowa	FAL 1000**	FAL 1120**	FAL 1120**	FAL 1120**	FAL 1250**	FAL 1250**	FAL 1250**	FAL 1250**
Kołnierż wlotowy	RAF 1000	RAF 1120	RAF 1120	RAF 1120	RAF 1250	RAF 1250	RAF 1250	RAF 1250
Złącze przeciwdrganiewe	EXP 1000	EXP 1120	EXP 1120	EXP 1120	EXP 1250	EXP 1250	EXP 1250	EXP 1250
Króciec wlotowy	ESD 1000	ESD 1120	ESD 1120	ESD 1120	ESD 1250	ESD 1250	ESD 1250	ESD 1250
Kłapa zwrotna pozioma	RVK H 1000	RVK H 1120	RVK H 1120	RVK H 1120	RVK H 1250	RVK H 1250	RVK H 1250	RVK H 1250
Kłapa zwrotna pionowa	RVK 1000	RVK 1120	RVK 1120	RVK 1120	RVK 1250	RVK 1250	RVK 1250	RVK 1250
Przylączka okrągłe	RVS 1000	RVS 1120	RVS 1120	RVS 1120	RVS 1250	RVS 1250	RVS 1250	RVS 1250
Siatka ochronna	SGW 1000/1120 SGE 1000	SGW 1120/1250 SGE 1120	SGW 1120/1250 SGE 1120	SGW 1120/1250 SGE 1120	SGW 1250/1400 SGE 1250	SGW 1250/1400 SGE 1250	SGW 1250/1400 SGE 1250	SGW 1250/1400 SGE 1250
Wibroizolator gumowy	FSD 08	FSD 08	FSD 08	FSD 09	FSD 08	FSD 09	FSD 09	FSD 09
Wibroizolator sprężynowy	FSD 11	FSD 10	FSD 11	FSD 11	FSD 11	FSD 11	FSD 11	FSD 11
Belka poprzeczna	TRA 1000	TRA 1120-1250	TRA 1120-1250	TRA 1120-1250	TRA 1120-1250	TRA 1120-1250	TRA 1120-1250	TRA 1120-1250
Pierścień montażowy	MR 1000	MR 1120	MR 1120	MR 1120	MR 1250	MR 1250	MR 1250	MR 1250

* Dla wentylatorów o średnicach 1000-1250 mm konieczny jest montaż przylączka okrągłego RVS po stronie tłocznej.

** Dla wentylatorów o średnicach 1000-1250mm, w przypadku stosowania stop montażowych FAL, konieczne jest zastosowanie 2 sztuk belek poprzecznych TRA.

*** Falownik jest obligatoryjny (częstotliwość maksymalna < 50Hz)

dane techniczne

Typ	\dot{V}_{max} [m ³ /h]	Δp_{max} [Pa]	P_{max} [W]	U_n [V]	f_{nom} [Hz]	$f_{min} - f_{max}$ [Hz]	I_{max} [A]	RPM _{max} [1/min]	T_{max} [C]	L_{WA} [dBa]	L_{pA}^* [dBa]	m [kg]	nr katalogowy
MAXEE 315/4/3900T	3940	215	170	3~400 (Y)	50	20-80	0,7	2355	60	65	58	19,3	15413200
MAXEE 315/2/5800T	5805	490	1380	3~400 (Y)	50	20-60	1,9	3460	60	75	68	18,5	15413400
MAXEE 355/4/4800T	4870	230	570	3~400 (Y)	50	20-70	0,8	2050	60	65	58	20,3	15412300
MAXEE 355/2/6900T	6915	440	1520	3~400 (Y)	50	20-50	2,3	2910	60	73	66	21,2	15412500
MAXEE 400/4/6800T	6890	300	1010	3~400 (Y)	50	20-70	1,3	2040	60	69	62	23,2	15409000
MAXEE 400/2/10800T	10820	750	3490	3~400 (Y)	50	20-55	4,5	3210	60	77	70	29,7	15409600
MAXEE 450/4/8400T	8460	280	1130	3~400 (Y)	50	20-60	1,4	1750	60	69	62	25,4	15410000
MAXEE 450/2/15300T	15300	960	6320	3~400 (Δ)	50	20-55	8,1	3220	60	83	76	45,6	15410600
MAXEE 500/4/11600T	11640	360	1820	3~400 (Y)	50	20-60	2,5	1760	60	71	64	38,5	15411100
MAXEE 500/2/19600T	19630	970	5930	3~400 (Δ)	50	20-50	10,8	2955	60	85	78	69,3	15411800
MAXEE 560/4/15300T	15380	350	2580	3~400 (Y)	50	20-55	3,4	1610	60	72	65	42,1	15415800
MAXEE 560/4/16500T	16580	430	3160	3~400 (Y)	50	20-60	4,0	1760	60	74	67	49,3	15416000
MAXEE 630/4/24600T	24620	625	5680	3~400 (Δ)	50	20-65	9,1	1910	60	79	72	65,2	15415200
MAXEE 630/6/16100T	16170	260	1240	3~400 (Y)	50	20-65	3,0	1260	60	70	63	52	15415400
MAXEE 710/6/22500T	22569	320	2210	3~400 (Y)	50	20-60	4,7	1180	60	73	66	72,5	15413800
MAXEE 710/4/36500T	33665	715	8500	3~400 (Δ)	50	20-60	14,0	1920	60	84	77	98,5	15414100
MAXEE 800/6/26500T	26520	280	3298	3~400 (Y)	50	20-50	5,2	980	60	80	73	114,1	16250100
MAXEE 800/4/30800T**	30800	380	3816	3~400 (Δ)	50	20-40	9,8	1150	60	81	74	117,1	16252000
MAXEE 800/4/31600T**	31640	780	4780	3~400 (Δ)	50	20-40	9,9	1180	60	81	74	142,1	16253000
MAXEE 800/6/36800T	36860	530	6296	3~400 (Δ)	50	20-70	12,1	1370	60	85	78	161,1	16254300
MAXEE 800/4/39900T	39890	650	7656	3~400 (Δ)	50	20-50	14,5	1480	60	88	81	153,1	16256400
MAXEE 800/4/48700T	48730	900	9704	3~400 (Δ)	50	20-60	23,9	1780	60	89	82	186,1	16246300
MAXEE 900/4/43300T**	43340	440	6500	3~400 (Δ)	50	20-40	14,9	1170	60	84	77	158,2	16268800
MAXEE 900/6/43400T	43390	990	6601	3~400 (Δ)	50	20-60	13,1	1170	60	83	76	177,2	16269500
MAXEE 900/4/49400T**	49365	580	9518	3~400 (Δ)	50	20-45	18,3	1320	60	87	80	169,2	16270200
MAXEE 900/4/54700T	54730	760	13233	3~400 (Δ)	50	20-50	25,2	1480	60	90	83	200,8	16267600
MAXEE 900/4/60300T	60285	920	17319	3~400 (Δ)	50	20-55	31	1630	60	90	83	244,8	16268300
MAXEE 1000/6/49300T	49290	400	6663	3~400 (Δ)	50	20-50	14,4	980	60	85	78	195	16265200
MAXEE 1000/4/60000T**	60040	600	11300	3~400 (Δ)	50	20-40	26,8	1180	60	85	78	220	16261800
MAXEE 1000/6/60100T	60140	610	15647	3~400 (Δ)	50	20-60	21,5	1185	60	85	78	265	16263100
MAXEE 1000/4/67500T**	67550	1160	16042	3~400 (Δ)	50	20-45	32,8	1330	60	89	82	264	16263600
MAXEE 1000/4/75800T	75810	980	22034	3~400 (Δ)	50	20-50	41,1	1490	60	91	84	313	16264800
MAXEE 1000/4/76100T	76095	970	23206	3~400 (Δ)	50	20-50	41,4	1480	60	94	87	280	16264100
MAXEE 1120/6/62200T**	62250	390	7053	3~400 (Δ)	50	20-45	16,2	860	60	87	80	218	16271500
MAXEE 1120/6/71400T	71380	545	12903	3~400 (Δ)	50	20-50	23,6	990	60	93	86	298	16270700
MAXEE 1120/6/85800T	85820	765	20147	3~400 (Δ)	50	20-60	37,8	1190	60	94	87	345	16271100
MAXEE 1250/6/79400T**	79450	420	10850	3~400 (Δ)	50	20-40	25,9	780	60	87	80	280	16257300
MAXEE 1250/6/98500T	98520	670	21529	3~400 (Δ)	50	20-50	40,5	990	60	96	89	365	16257900
MAXEE 1250/6/109300T	109260	835	28129	3~400 (Δ)	50	20-55	52	1080	60	95	88	376	16258300
MAXEE 1250/6/119600T	119640	1015	37683	3~400 (Δ)	50	20-60	68,8	1190	60	96	89	550	16259200

* Poziom ciśnienia akustycznego w odległości 3 m od obudowy

** W związku z maksymalną dopuszczalną częstotliwością, urządzenia muszą być sterowane za pomocą falownika

schematy elektryczne

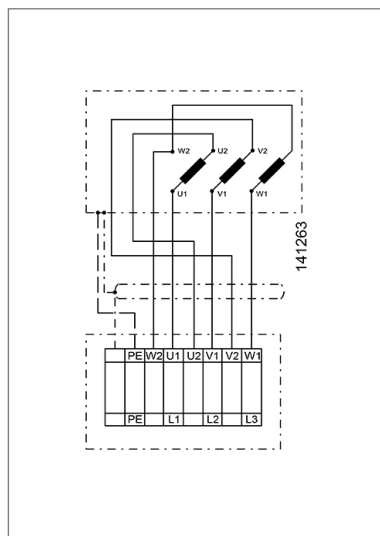

wymiary

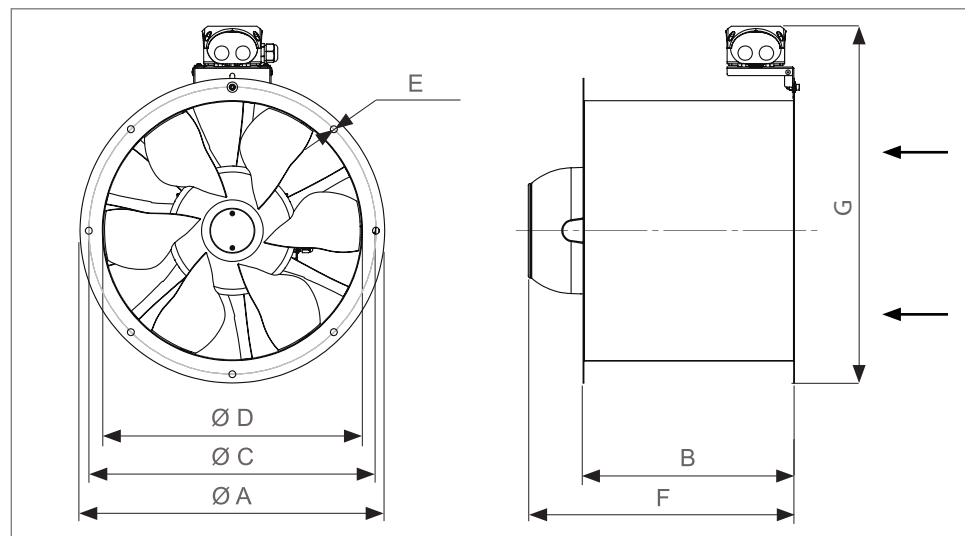

wymiary

Typ	A [mm]	B[mm]	C [mm]	D [mm]	E [mm]	F [mm]	G [mm]
MAXEE 315/4/3900T	380	383	355	315	8 x Ø10	-	473
MAXEE 315/2/5800T	380	383	355	315	8 x Ø10	-	473
MAXEE 355/4/4800T	420	383	395	355	8 x Ø10	-	513
MAXEE 355/2/6900T	420	383	395	355	8 x Ø10	-	513
MAXEE 400/4/6800T	480	368	450	400	8 x Ø12	-	571
MAXEE 400/2/10800T	480	368	450	400	8 x Ø12	395	571
MAXEE 450/4/8400T	530	368	500	450	8 x Ø12	-	621
MAXEE 450/2/15300T	530	368	500	450	8 x Ø12	464	621
MAXEE 500/4/11600T	590	443	560	500	12 x Ø12	-	681
MAXEE 500/2/19600T	590	443	560	500	12 x Ø12	553	681
MAXEE 560/4/15300T	650	443	620	560	12 x Ø12	-	741
MAXEE 560/4/16500T	650	443	620	560	12 x Ø12	474	738
MAXEE 630/4/24600T	720	443	690	630	12 x Ø12	503	810
MAXEE 630/6/16100T	720	443	690	630	12 x Ø12	486	810
MAXEE 710/6/22500T	810	433	770	710	16 x Ø12	515	895
MAXEE 710/4/36500T	810	433	770	710	16 x Ø12	601	895
MAXEE 800/6/26500T	900	648	860	800	16 x Ø12	-	975
MAXEE 800/4/30800T	900	648	860	800	16 x Ø12	-	975
MAXEE 800/4/31600T	900	648	860	800	16 x Ø12	-	975
MAXEE 800/6/36800T	900	648	860	800	16 x Ø12	669	975
MAXEE 800/4/39900T	900	648	860	800	16 x Ø12	-	975
MAXEE 800/4/48700T	900	648	860	800	16 x Ø12	769	981

wymiary

Typ	A [mm]	B[mm]	C [mm]	D [mm]	E [mm]	F [mm]	G [mm]
MAXEE 900/4/43300T	1010	638	970	900	16 x Ø15	-	1081
MAXEE 900/6/43400T	1010	638	970	900	16 x Ø15	694	1081
MAXEE 900/4/49400T	1010	638	970	900	16 x Ø15	670	1081
MAXEE 900/4/54700T	1010	638	970	900	16 x Ø15	794	1087
MAXEE 900/4/60300T	1010	638	970	900	16 x Ø15	786	1087
MAXEE 1000/6/49300T	1110	638	1070	1000	16 x Ø15	714	1182
MAXEE 1000/4/60000T	1110	638	1070	1000	16 x Ø15	814	1188
MAXEE 1000/6/60100T	1110	638	1070	1000	16 x Ø15	806	1188
MAXEE 1000/4/67500T	1110	638	1070	1000	16 x Ø15	806	1188
MAXEE 1000/4/75800T	1110	638	1070	1000	16 x Ø15	864	1188
MAXEE 1000/4/76100T	1110	638	1070	1000	16 x Ø15	864	1188
MAXEE 1120/6/62200T	1240	728	1190	1120	20 x Ø15	744	1307
MAXEE 1120/6/71400T	1240	728	1190	1120	20 x Ø15	836	1314
MAXEE 1120/6/85800T	1240	728	1190	1120	20 x Ø15	958	1314
MAXEE 1250/6/79400T	1370	728	1320	1250	20 x Ø15	866	1445
MAXEE 1250/6/98500T	1370	728	1320	1250	20 x Ø15	988	1445
MAXEE 1250/6/109300T	1370	728	1320	1250	20 x Ø15	988	1445
MAXEE 1250/6/119600T	1370	728	1320	1250	20 x Ø15	1087	1461

charakterystyki pracy

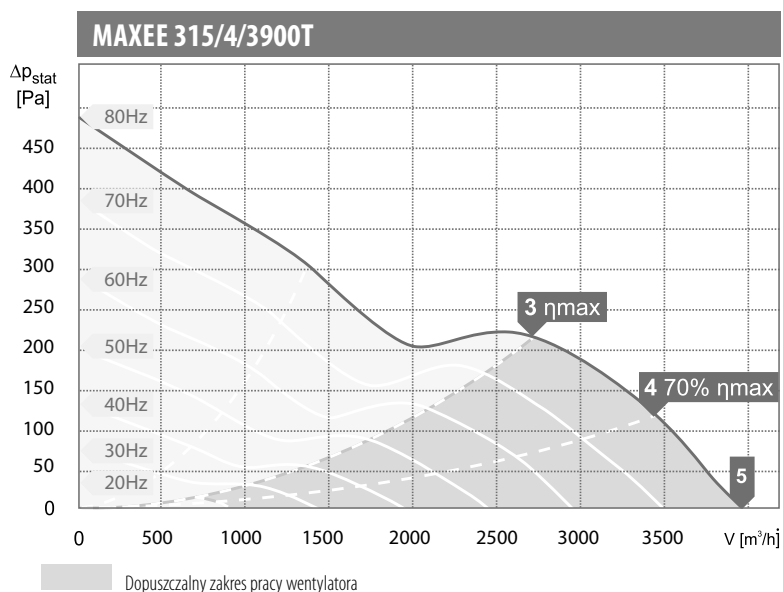

wartości mocy akustycznej L_{wa} [dB(A)]
dla poszczególnych częstotliwości pasm oktaowych [Hz]

Pkt. Pracy	Częstotliwości pasm oktaowych [Hz]								
	tot	63	125	250	500	1000	2000	4000	8000
L_{wa} wlot [dB(A)]									
3	82	50	64	76	77	76	75	69	60
4	85	35	38	60	72	84	78	70	61
5	84	32	43	63	71	81	79	70	59
L_{wa} wylot [dB(A)]									
3	83	51	70	76	77	77	76	69	60
4	83	34	49	70	74	81	76	69	61
5	83	31	44	67	74	81	77	70	59
L_{wa} od obudowy [dB(A)]									
3	65	49	52	58	56	58	55	51	43
4	71	27	34	47	55	71	58	51	43
5	70	30	35	52	54	70	57	50	42

charakterystyki pracy

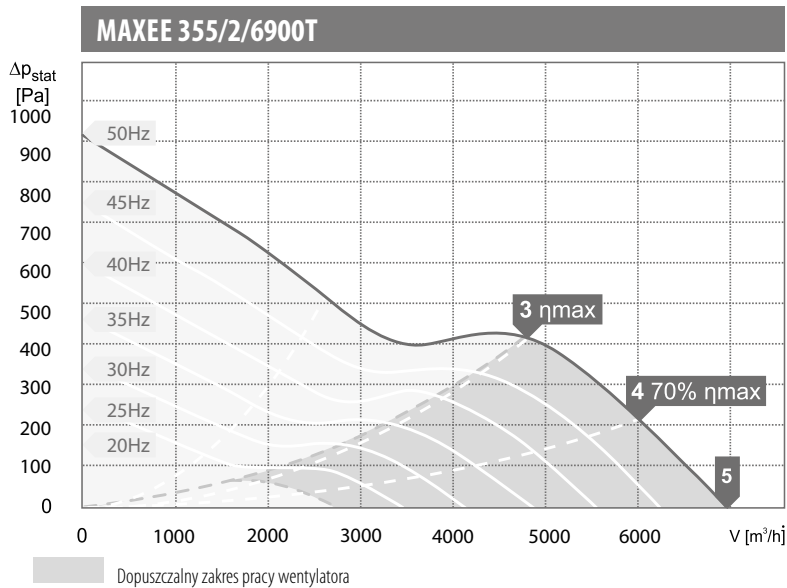
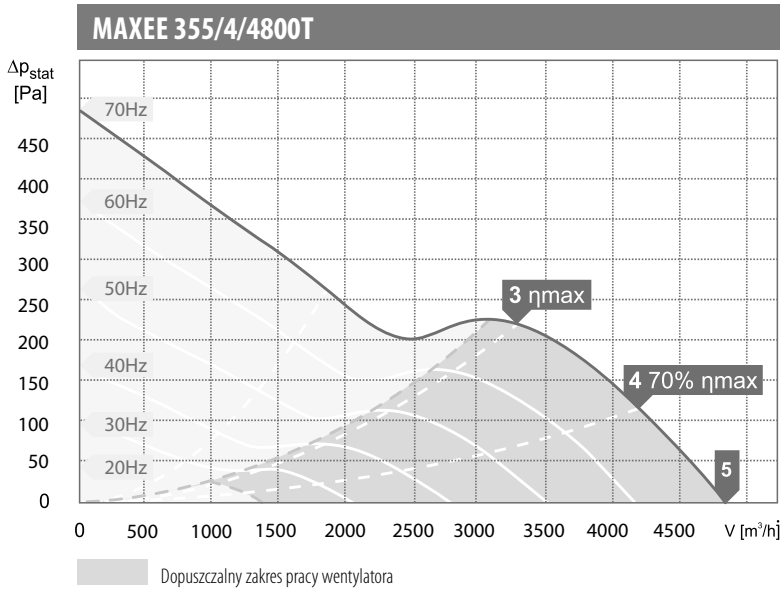
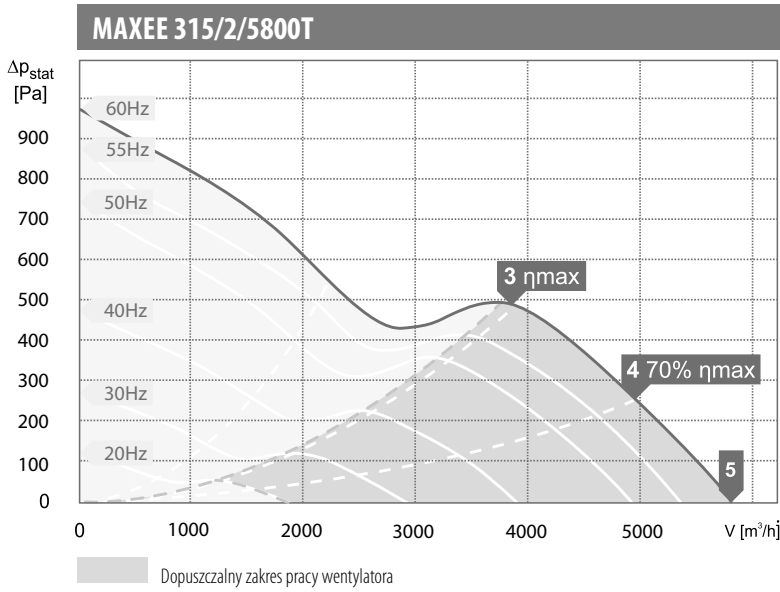

wartości mocy akustycznej L_{WA} [dB(A)]
dla poszczególnych częstotliwości pasm oktaowych [Hz]

Pkt. Pracy	tot	Częstotliwości pasm oktaowych [Hz]							
		63	125	250	500	1000	2000	4000	8000
L_{WA} wlot [dB(A)]									
3	90	42	51	74	83	85	84	80	72
4	91	42	49	73	85	87	86	82	73
5	91	41	50	74	84	87	86	82	72
L_{WA} wylot [dB(A)]									
3	94	60	74	88	88	88	87	81	72
4	94	36	47	71	88	90	88	81	73
5	93	41	51	74	86	89	88	81	72
L_{WA} od obudowy [dB(A)]									
3	75	60	59	72	66	65	66	61	56
4	73	37	39	63	61	61	72	60	56
5	72	42	41	60	62	61	71	60	53

Pkt. Pracy	tot	Częstotliwości pasm oktaowych [Hz]							
		63	125	250	500	1000	2000	4000	8000
L_{WA} wlot [dB(A)]									
3	82	47	61	72	77	76	75	69	60
4	83	26	41	58	76	79	78	70	60
5	83	30	44	61	74	79	79	71	58
L_{WA} wylot [dB(A)]									
3	83	52	71	74	77	77	75	68	59
4	83	36	55	68	74	79	77	69	59
5	83	32	51	69	75	80	78	70	59
L_{WA} od obudowy [dB(A)]									
3	65	51	56	54	59	58	54	51	40
4	66	37	44	48	60	63	56	52	40
5	67	30	38	46	58	65	56	52	39

Pkt. Pracy	tot	Częstotliwości pasm oktaowych [Hz]							
		63	125	250	500	1000	2000	4000	8000
L_{WA} wlot [dB(A)]									
3	92	59	69	84	87	86	84	79	70
4	94	48	47	75	87	91	87	81	70
5	93	51	51	77	90	88	87	82	70
L_{WA} wylot [dB(A)]									
3	94	44	58	73	90	89	85	80	71
4	96	44	54	73	90	92	88	80	71
5	96	47	53	74	91	93	88	81	71
L_{WA} od obudowy [dB(A)]									
3	73	59	51	55	67	66	68	59	52
4	75	59	42	49	68	68	72	60	51
5	73	59	43	51	67	66	69	61	50

charakterystyki pracy

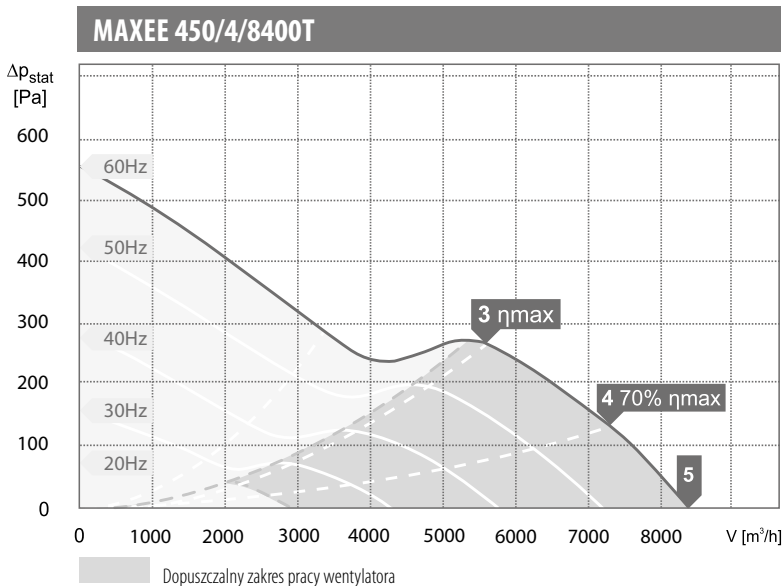
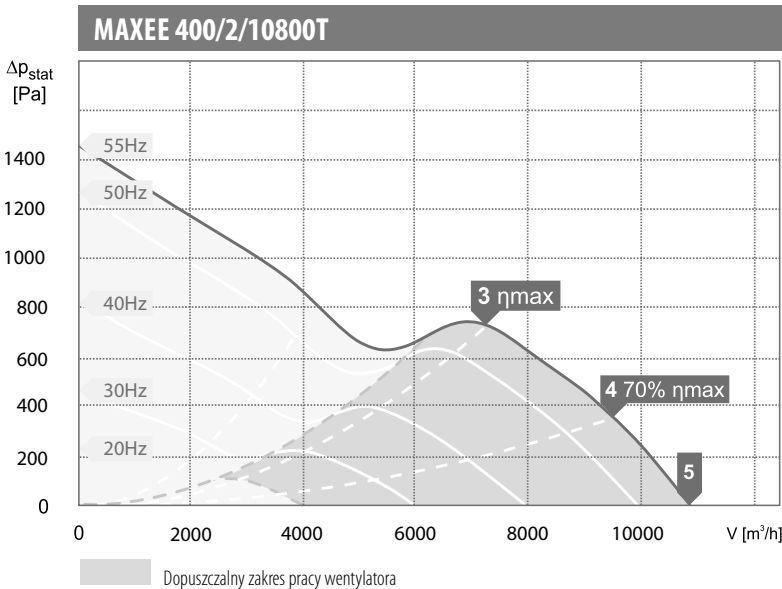
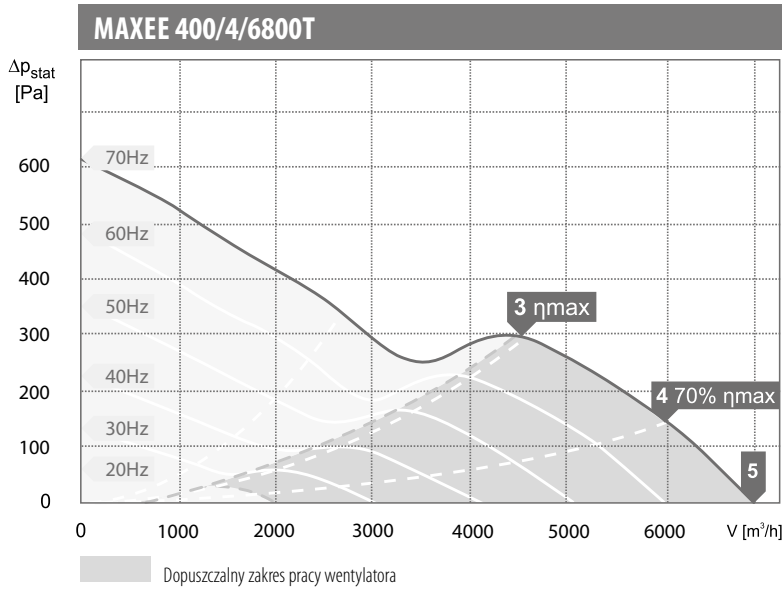

wartości mocy akustycznej L_{WA} [dB(A)]
dla poszczególnych częstotliwości pasm oktawowych [Hz]

Pkt. Pracy	tot	Częstotliwości pasm oktawowych [Hz]							
		63	125	250	500	1000	2000	4000	8000
L_{WA} wlot [dB(A)]									
3	84	43	53	66	77	81	78	72	62
4	84	40	47	62	76	81	78	72	62
5	85	40	47	61	78	82	79	73	61
L_{WA} wylot [dB(A)]									
3	85	45	63	73	79	80	77	71	63
4	85	34	54	71	79	82	78	71	62
5	85	36	55	73	79	82	79	72	61
L_{WA} od obudowy [dB(A)]									
3	69	42	49	55	67	63	57	51	41
4	71	27	40	53	67	69	58	51	40
5	71	40	41	53	66	68	58	52	40

Pkt. Pracy	tot	Częstotliwości pasm oktawowych [Hz]							
		63	125	250	500	1000	2000	4000	8000
L_{WA} wlot [dB(A)]									
3	97	58	63	83	91	90	90	84	75
4	98	56	53	78	95	87	94	85	76
5	99	55	55	79	96	86	93	85	75
L_{WA} wylot [dB(A)]									
3	99	52	60	76	95	94	90	84	76
4	100	54	58	76	96	96	94	86	76
5	101	58	60	79	98	96	94	86	77
L_{WA} od obudowy [dB(A)]									
3	77	64	63	69	70	72	67	61	53
4	77	47	49	56	69	73	73	63	51
5	76	46	48	55	69	72	70	62	52

Pkt. Pracy	tot	Częstotliwości pasm oktawowych [Hz]							
		63	125	250	500	1000	2000	4000	8000
L_{WA} wlot [dB(A)]									
3	86	42	59	75	82	81	76	71	61
4	89	35	53	71	86	84	76	70	62
5	89	36	53	72	85	85	76	71	65
L_{WA} wylot [dB(A)]									
3	85	53	70	74	80	80	76	71	62
4	89	37	66	74	86	83	77	70	62
5	89	38	65	75	86	84	78	71	65
L_{WA} od obudowy [dB(A)]									
3	70	45	52	63	66	64	56	50	40
4	76	30	44	63	72	74	57	49	38
5	76	33	46	64	72	74	56	50	41

charakterystyki pracy

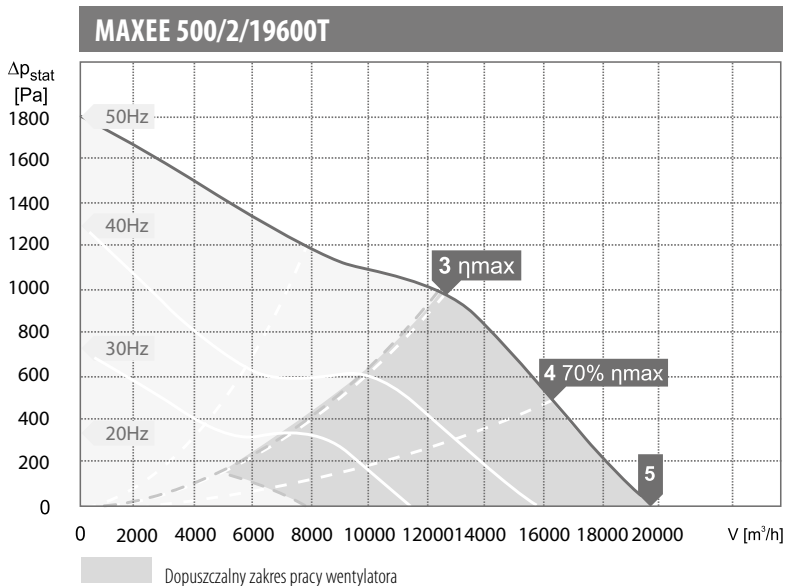
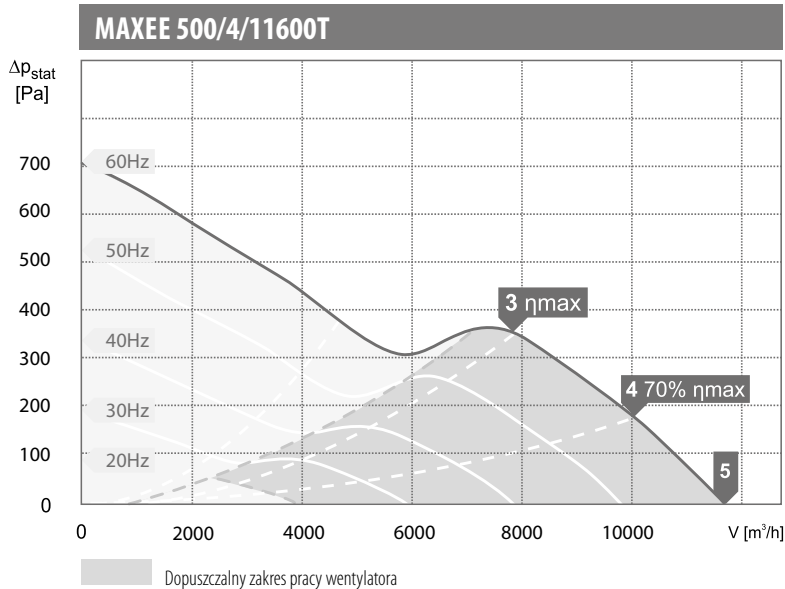
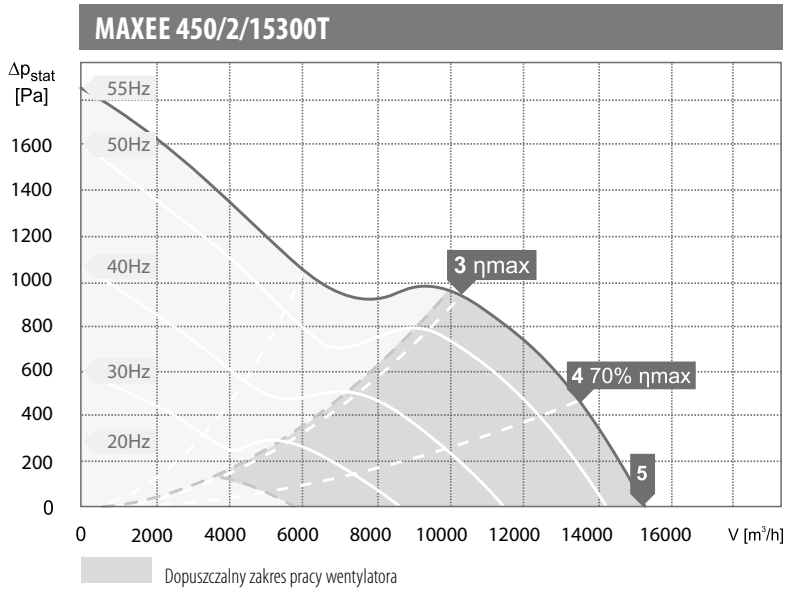

wartości mocy akustycznej L_{WA} [dB(A)]
dla poszczególnych częstotliwości pasm oktaowych [Hz]

Pkt. Pracy	tot	Częstotliwości pasm oktaowych [Hz]							
		63	125	250	500	1000	2000	4000	8000
L_{WA} wlot [dB(A)]									
3	102	68	79	94	98	96	93	88	80
4	101	62	55	83	98	93	97	88	80
5	102	59	58	84	99	92	97	89	79
L_{WA} wylot [dB(A)]									
3	102	75	91	98	101	98	93	88	79
4	105	52	57	82	103	99	97	89	81
5	105	57	63	84	102	99	97	90	81
L_{WA} od obudowy [dB(A)]									
3	83	69	70	76	78	77	72	67	58
4	84	52	53	65	73	84	75	67	57
5	84	54	54	66	74	83	75	68	57

Pkt. Pracy	tot	Częstotliwości pasm oktaowych [Hz]							
		63	125	250	500	1000	2000	4000	8000
L_{WA} wlot [dB(A)]									
3	88	54	67	81	83	83	80	74	67
4	88	39	58	77	82	85	80	74	64
5	88	40	60	77	81	85	80	74	63
L_{WA} wylot [dB(A)]									
3	90	65	80	80	85	85	80	75	66
4	90	41	72	78	82	87	82	74	64
5	90	42	72	80	83	87	83	75	64
L_{WA} od obudowy [dB(A)]									
3	70	43	51	60	65	67	58	53	45
4	74	38	47	55	69	72	62	53	42
5	73	39	49	56	67	70	62	54	42

Pkt. Pracy	tot	Częstotliwości pasm oktaowych [Hz]							
		63	125	250	500	1000	2000	4000	8000
L_{WA} wlot [dB(A)]									
3	101	55	83	83	96	93	96	88	80
4	103	57	75	84	98	95	99	90	81
5	103	57	63	85	98	94	99	90	81
L_{WA} wylot [dB(A)]									
3	104	63	78	89	100	98	94	89	81
4	105	53	66	86	102	99	97	90	81
5	107	55	68	87	104	101	99	92	83
L_{WA} od obudowy [dB(A)]									
3	85	66	72	75	80	80	75	71	68
4	84	50	58	74	75	81	77	72	67
5	84	52	60	71	77	80	78	71	63

charakterystyki pracy

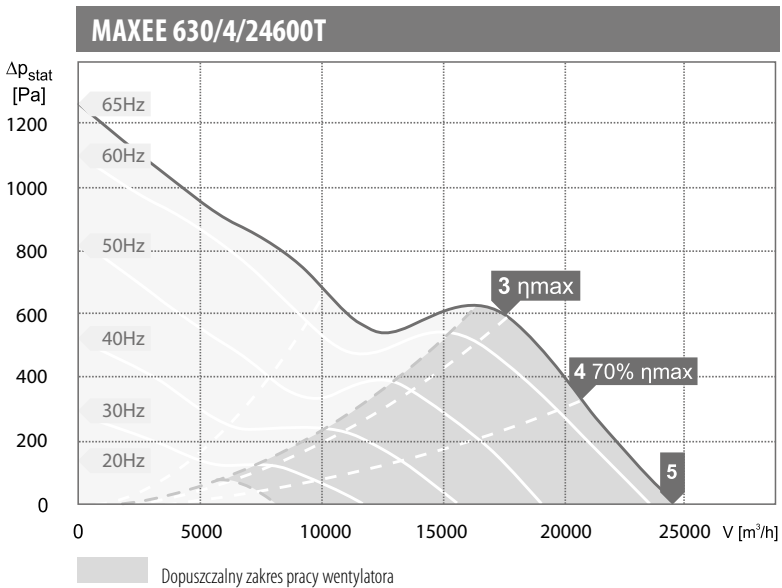
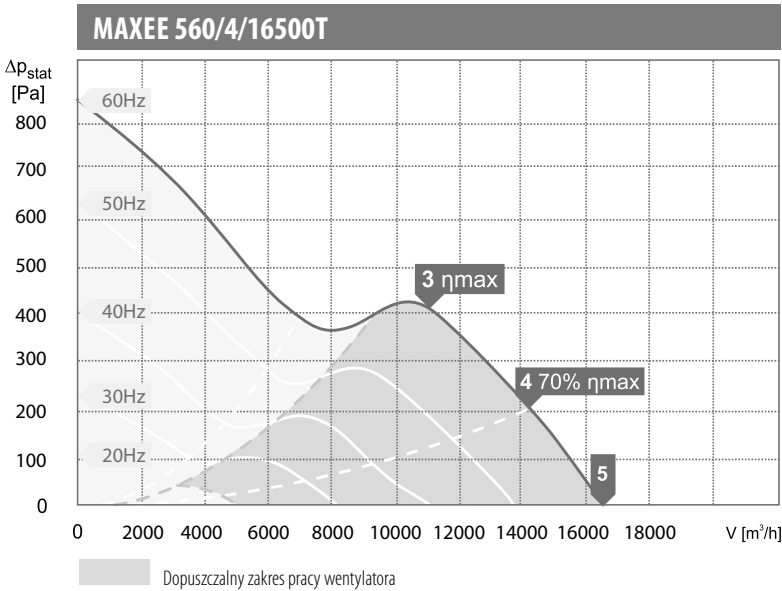
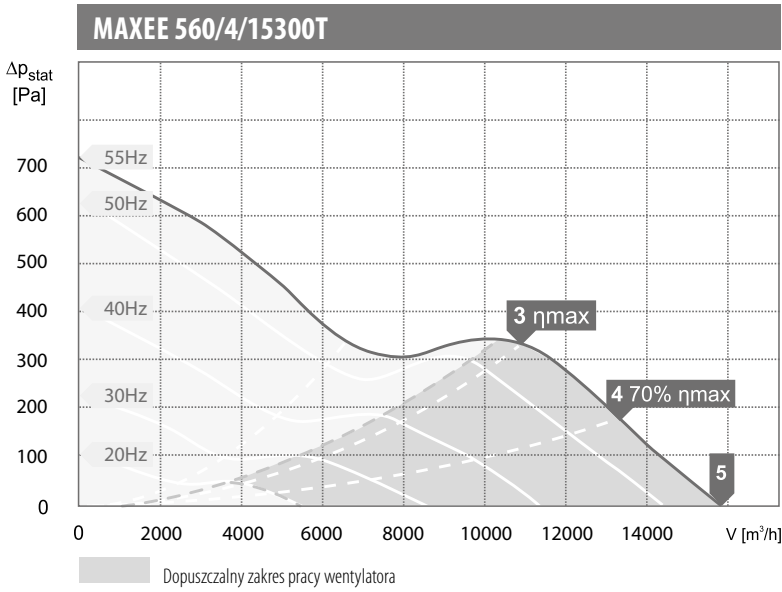

wartości mocy akustycznej L_{WA} [dB(A)]
dla poszczególnych częstotliwości pasm oktaowych [Hz]

Pkt. Pracy	tot	Częstotliwości pasm oktaowych [Hz]							
		63	125	250	500	1000	2000	4000	8000
L_{WA} wlot [dB(A)]									
3	90	49	65	81	83	85	82	77	68
4	90	43	62	81	84	86	82	77	68
5	90	43	62	81	84	86	82	75	65
L_{WA} wylot [dB(A)]									
3	91	51	74	83	84	86	82	77	68
4	92	48	75	85	85	89	83	77	69
5	92	48	75	85	84	88	83	77	67
L_{WA} od obudowy [dB(A)]									
3	72	51	59	62	66	67	62	56	48
4	73	40	52	62	68	70	62	56	47
5	73	43	54	61	67	70	63	55	44

Pkt. Pracy	tot	Częstotliwości pasm oktaowych [Hz]							
		63	125	250	500	1000	2000	4000	8000
L_{WA} wlot [dB(A)]									
3	94	68	81	88	88	88	85	79	70
4	96	44	67	90	92	90	84	78	69
5	96	43	67	88	93	90	84	77	67
L_{WA} wylot [dB(A)]									
3	92	69	83	84	87	86	83	78	68
4	97	51	78	91	91	91	86	78	69
5	98	51	80	93	92	91	86	79	69
L_{WA} od obudowy [dB(A)]									
3	75	59	65	69	70	69	63	58	49
4	79	43	54	70	72	77	66	56	47
5	79	44	56	69	72	77	66	56	45

Pkt. Pracy	tot	Częstotliwości pasm oktaowych [Hz]							
		63	125	250	500	1000	2000	4000	8000
L_{WA} wlot [dB(A)]									
3	97	63	77	87	91	92	88	82	74
4	98	58	72	83	93	94	90	84	74
5	97	57	71	82	92	94	89	83	72
L_{WA} wylot [dB(A)]									
3	98	67	84	91	93	93	89	83	74
4	100	56	76	87	95	97	91	84	75
5	101	54	74	87	96	98	92	84	74
L_{WA} od obudowy [dB(A)]									
3	79	68	72	72	73	73	69	60	54
4	85	50	56	67	83	78	72	62	54
5	83	54	59	68	81	78	72	62	53

charakterystyki pracy

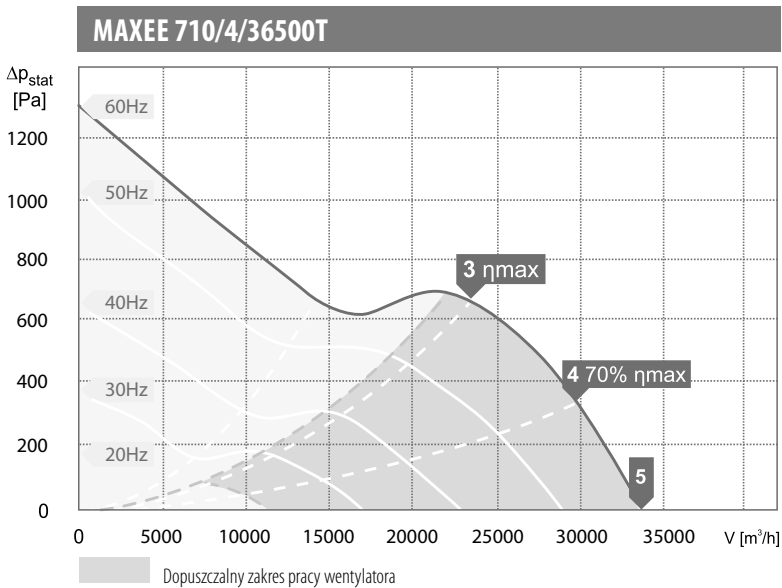
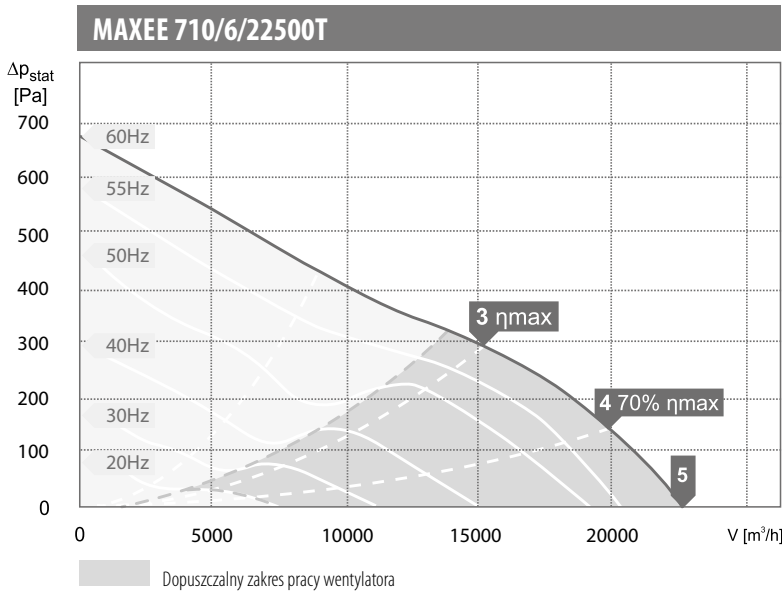
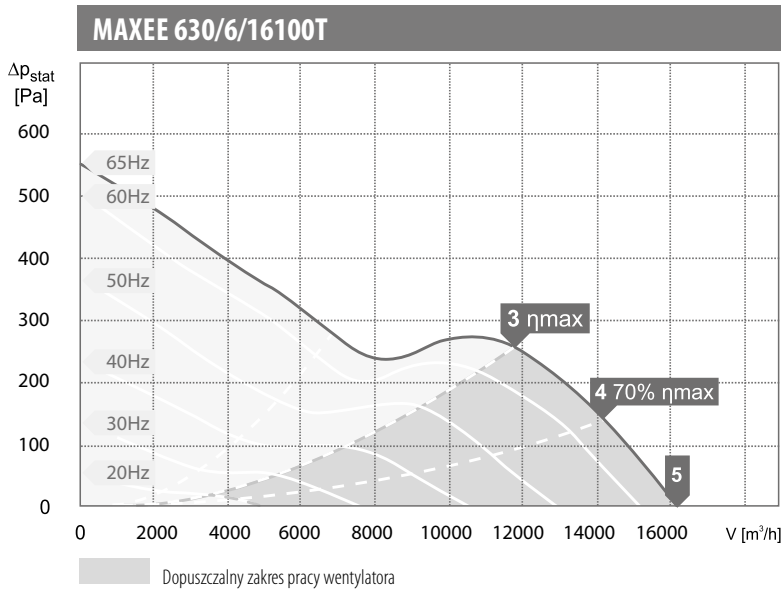

wartości mocy akustycznej L_{WA} [dB(A)]
dla poszczególnych częstotliwości pasm oktaowych [Hz]

Pkt. Pracy	tot	Częstotliwości pasm oktaowych [Hz]							
		63	125	250	500	1000	2000	4000	8000
L_{WA} wlot [dB(A)]									
3	87	62	71	79	82	81	77	71	64
4	90	46	61	76	87	84	77	70	61
5	90	44	60	75	88	84	77	70	61
L_{WA} wylot [dB(A)]									
3	86	62	74	78	81	81	77	71	64
4	91	52	70	78	89	83	78	71	62
5	92	48	69	78	91	83	78	71	62
L_{WA} od obudowy [dB(A)]									
3	70	62	63	60	64	63	62	50	42
4	73	38	51	62	72	67	63	48	42
5	73	43	54	62	71	65	63	48	42

Pkt. Pracy	tot	Częstotliwości pasm oktaowych [Hz]							
		63	125	250	500	1000	2000	4000	8000
L_{WA} wlot [dB(A)]									
3	88	65	74	81	83	82	79	75	70
4	89	59	70	81	85	84	79	73	67
5	91	50	66	81	86	86	79	73	66
L_{WA} wylot [dB(A)]									
3	88	65	76	81	84	82	78	74	67
4	93	53	71	85	90	87	80	74	66
5	93	52	72	86	90	87	80	74	66
L_{WA} od obudowy [dB(A)]									
3	73	66	63	64	67	65	60	54	48
4	76	60	62	69	71	68	60	50	44
5	78	52	61	74	73	69	60	50	43

Pkt. Pracy	tot	Częstotliwości pasm oktaowych [Hz]							
		63	125	250	500	1000	2000	4000	8000
L_{WA} wlot [dB(A)]									
3	101	73	85	93	96	96	92	86	78
4	102	71	82	93	97	99	94	88	81
5	101	65	78	89	94	98	92	86	78
L_{WA} wylot [dB(A)]									
3	100	71	86	93	95	95	91	85	77
4	104	68	84	95	99	100	94	88	79
5	104	60	81	93	98	100	94	86	77
L_{WA} od obudowy [dB(A)]									
3	84	72	78	76	78	77	72	65	55
4	86	68	73	78	81	81	76	68	58
5	84	59	68	77	79	80	76	64	54

charakterystyki pracy

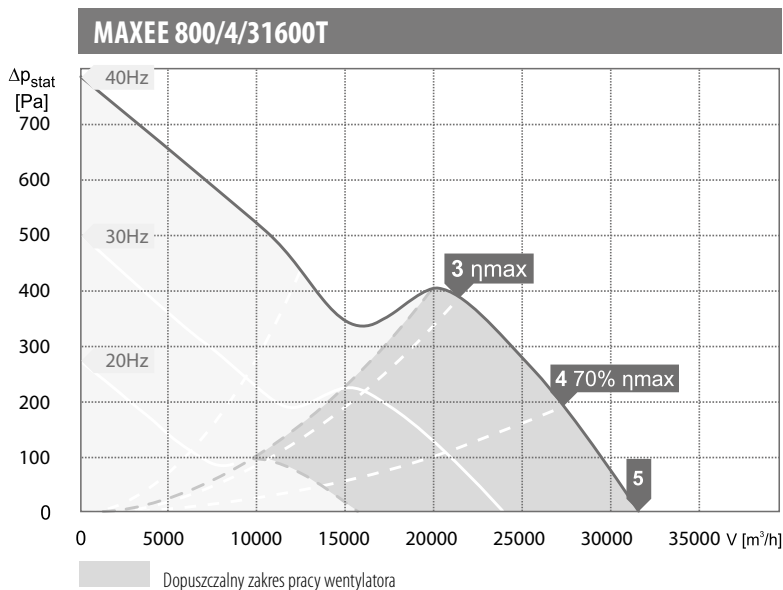
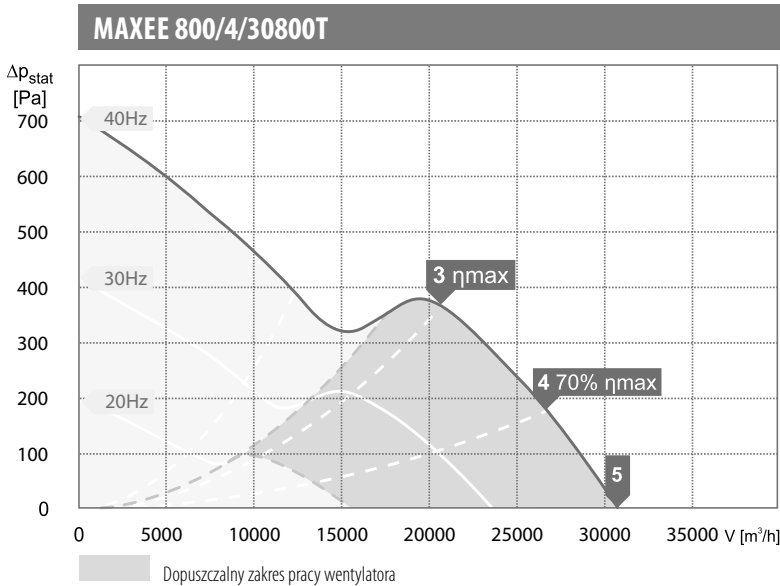
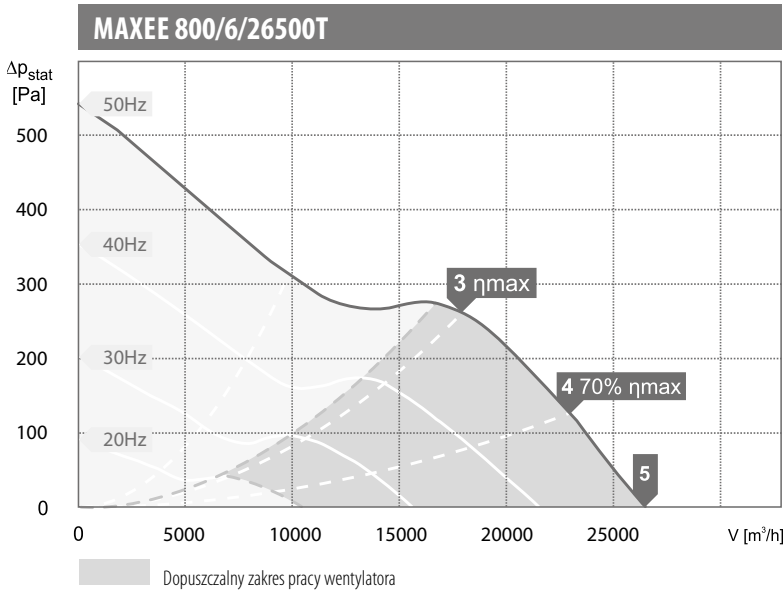

wartości mocy akustycznej L_{WA} [dB(A)]
dla poszczególnych częstotliwości pasm oktaowych [Hz]

Pkt. Pracy	tot	Częstotliwości pasm oktaowych [Hz]							
		63	125	250	500	1000	2000	4000	8000
L_{WA} wlot [dB(A)]									
3	93	70	77	90	87	86	82	79	72
4	94	62	74	91	88	87	83	78	71
5	95	58	73	91	89	88	83	77	71
L_{WA} wylot [dB(A)]									
3	92	71	80	85	87	86	82	78	71
4	98	61	77	90	96	91	84	77	70
5	97	62	77	90	95	90	84	77	70
L_{WA} od obudowy [dB(A)]									
3	80	71	67	78	72	70	65	57	51
4	82	66	70	79	77	73	65	55	49
5	84	60	72	81	80	74	66	54	48

Pkt. Pracy	tot	Częstotliwości pasm oktaowych [Hz]							
		63	125	250	500	1000	2000	4000	8000
L_{WA} wlot [dB(A)]									
3	97	76	82	91	92	92	88	83	77
4	99	75	80	92	94	95	90	84	76
5	99	67	75	92	94	96	89	83	76
L_{WA} wylot [dB(A)]									
3	97	77	83	90	92	91	87	82	77
4	100	73	83	92	95	95	89	83	76
5	102	64	80	94	97	97	90	83	75
L_{WA} od obudowy [dB(A)]									
3	81	76	73	73	74	73	68	64	54
4	83	74	72	76	78	76	70	63	53
5	84	68	70	79	81	78	70	62	52

Pkt. Pracy	tot	Częstotliwości pasm oktaowych [Hz]							
		63	125	250	500	1000	2000	4000	8000
L_{WA} wlot [dB(A)]									
3	97	75	82	91	92	91	87	82	76
4	100	74	80	92	95	95	90	84	77
5	99	67	75	92	94	96	89	83	76
L_{WA} wylot [dB(A)]									
3	97	76	83	90	92	91	87	82	76
4	100	73	83	92	95	95	89	83	76
5	102	64	80	94	97	97	90	83	75
L_{WA} od obudowy [dB(A)]									
3	81	75	72	72	74	73	68	63	53
4	83	74	72	76	79	77	70	63	53
5	84	68	70	79	81	78	70	62	52

charakterystyki pracy

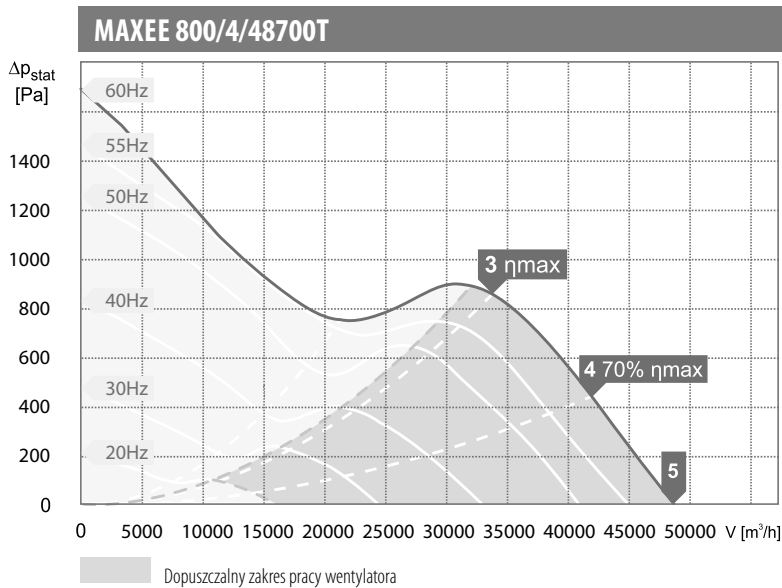
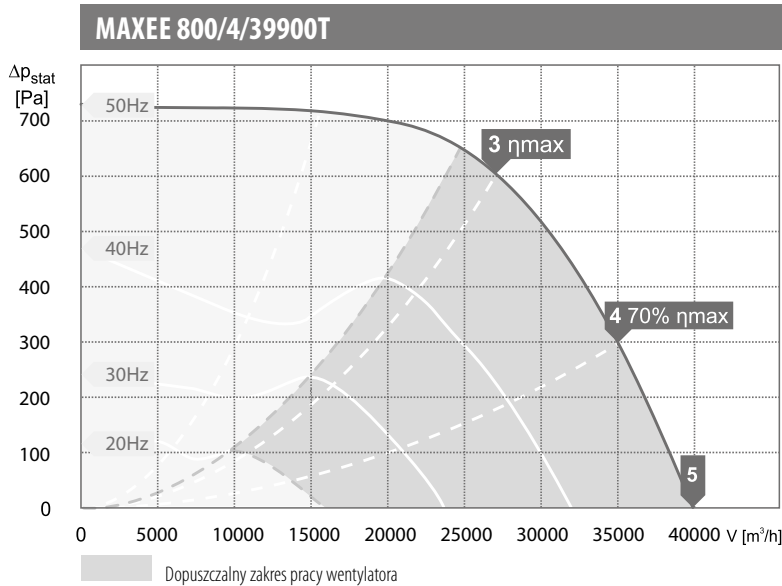
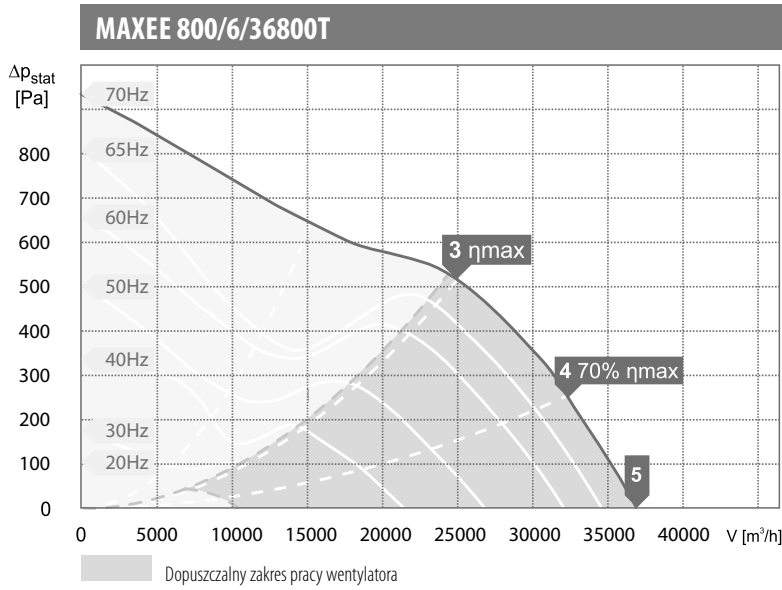

wartości mocy akustycznej L_{WA} [dB(A)]
dla poszczególnych częstotliwości pasm oktaowych [Hz]

Pkt. Pracy	tot	Częstotliwości pasm oktaowych [Hz]							
		63	125	250	500	1000	2000	4000	8000
L _{WA} wlot [dB(A)]									
3	101	78	86	93	96	95	91	87	82
4	102	72	83	94	97	97	91	86	80
5	103	63	78	94	99	99	92	86	79
L _{WA} wylot [dB(A)]									
3	100	80	89	94	96	95	91	86	80
4	106	63	83	99	103	100	93	86	78
5	106	65	84	98	103	100	93	86	78
L _{WA} od obudowy [dB(A)]									
3	85	79	76	76	80	78	72	66	60
4	87	73	75	82	83	80	73	63	57
5	90	64	74	87	86	82	73	62	55

Pkt. Pracy	tot	Częstotliwości pasm oktaowych [Hz]							
		63	125	250	500	1000	2000	4000	8000
L _{WA} wlot [dB(A)]									
3	106	80	89	102	99	98	94	89	83
4	108	76	86	105	101	101	96	90	83
5	110	68	81	109	102	102	96	90	82
L _{WA} wylot [dB(A)]									
3	105	80	90	101	99	98	94	88	82
4	109	73	88	106	102	102	96	90	82
5	113	66	87	111	104	104	98	90	82
L _{WA} od obudowy [dB(A)]									
3	88	78	81	82	80	80	75	71	60
4	90	74	77	87	83	85	78	70	59
5	93	66	73	90	84	88	79	69	59

Pkt. Pracy	tot	Częstotliwości pasm oktaowych [Hz]							
		63	125	250	500	1000	2000	4000	8000
L _{WA} wlot [dB(A)]									
3	107	79	91	100	102	101	97	92	86
4	111	83	95	103	106	106	102	96	88
5	111	78	90	101	105	107	102	96	88
L _{WA} wylot [dB(A)]									
3	107	79	92	99	102	101	97	92	85
4	111	81	95	103	106	106	101	95	87
5	112	75	92	103	107	108	103	96	87
L _{WA} od obudowy [dB(A)]									
3	89	77	82	82	83	82	78	75	64
4	94	81	87	86	89	87	82	76	66
5	94	75	80	86	89	89	84	75	65

charakterystyki pracy

MAXEE 900/4/43300T

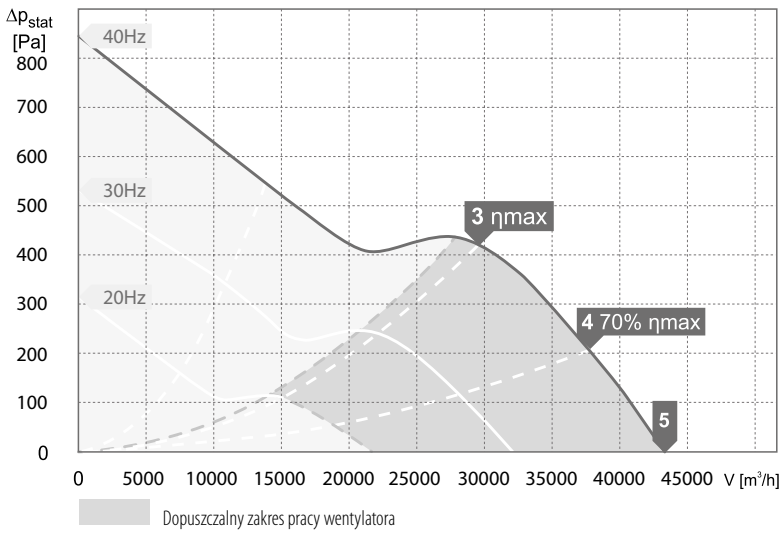

wartości mocy akustycznej L_{WA} [dB(A)]
dla poszczególnych częstotliwości pasm oktaowych [Hz]

Pkt. Pracy	tot	Częstotliwości pasm oktaowych [Hz]							
		63	125	250	500	1000	2000	4000	8000
L_{WA} wlot [dB(A)]									
3	100	79	85	94	95	95	91	86	79
4	102	78	83	95	97	97	92	86	79
5	102	69	77	94	96	98	91	85	78
L_{WA} wylot [dB(A)]									
3	100	80	86	93	95	94	90	85	79
4	102	76	85	95	98	97	92	86	79
5	104	66	82	96	99	100	92	85	77
L_{WA} od obudowy [dB(A)]									
3	84	79	76	76	77	76	71	67	57
4	86	77	75	79	81	79	73	66	56
5	87	70	72	81	83	80	72	65	54

MAXEE 900/6/43400T

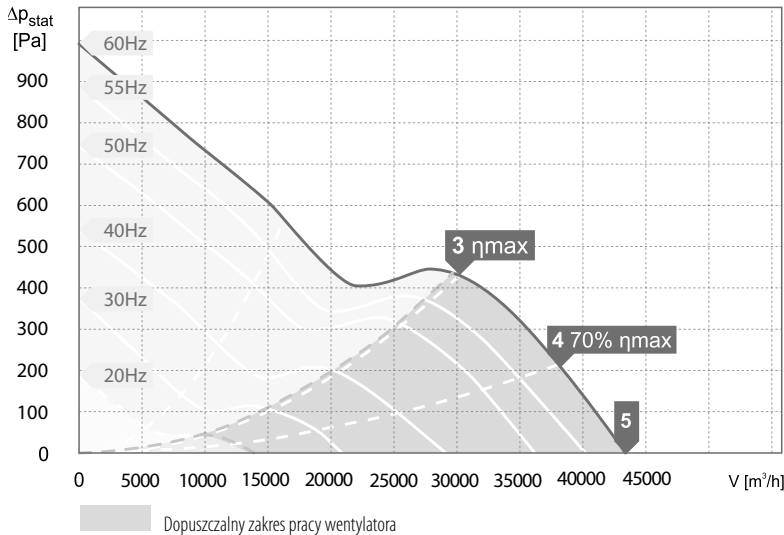

Pkt. Pracy	tot	Częstotliwości pasm oktaowych [Hz]							
		63	125	250	500	1000	2000	4000	8000
L_{WA} wlot [dB(A)]									
3	99	76	85	92	94	93	89	85	80
4	100	72	82	92	96	95	90	85	79
5	101	61	77	92	97	97	90	84	77
L_{WA} wylot [dB(A)]									
3	100	75	86	93	96	94	89	84	78
4	105	63	83	97	102	99	92	85	77
5	104	63	83	97	101	98	91	85	77
L_{WA} od obudowy [dB(A)]									
3	83	76	74	75	78	76	70	64	58
4	86	73	74	80	82	79	71	62	56
5	89	63	72	85	84	80	71	60	54

MAXEE 900/4/49400T

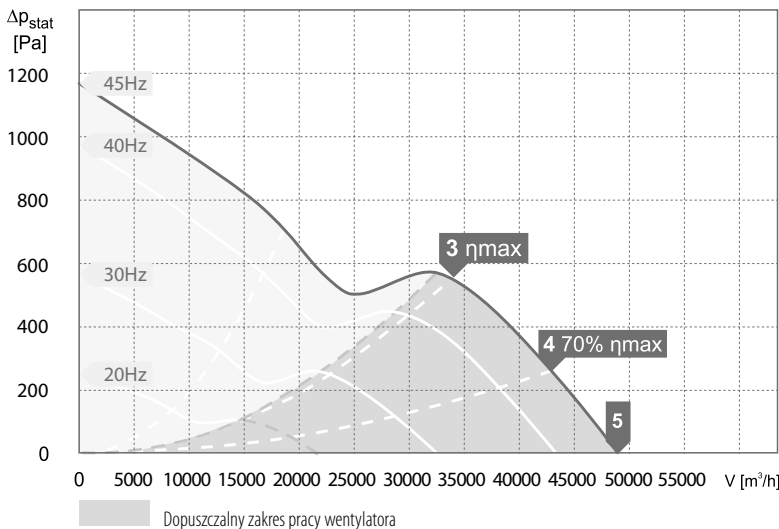

Pkt. Pracy	tot	Częstotliwości pasm oktaowych [Hz]							
		63	125	250	500	1000	2000	4000	8000
L_{WA} wlot [dB(A)]									
3	104	81	88	99	99	98	94	89	82
4	107	79	87	101	101	101	96	90	83
5	106	69	80	101	100	101	95	89	81
L_{WA} wylot [dB(A)]									
3	104	80	89	98	98	97	93	88	82
4	107	77	89	102	102	102	96	90	82
5	108	67	85	103	103	103	96	89	81
L_{WA} od obudowy [dB(A)]									
3	87	80	80	80	80	80	75	70	60
4	90	78	78	84	84	84	77	70	60
5	90	69	73	86	85	86	77	68	58

charakterystyki pracy

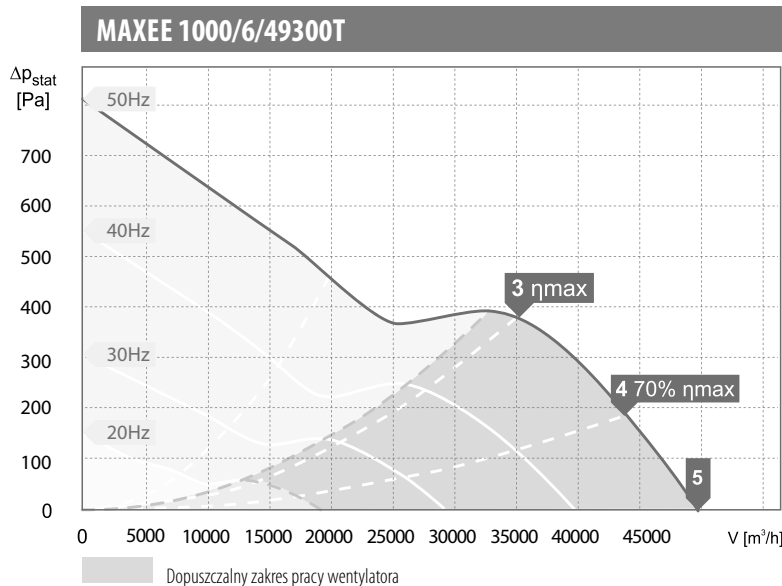
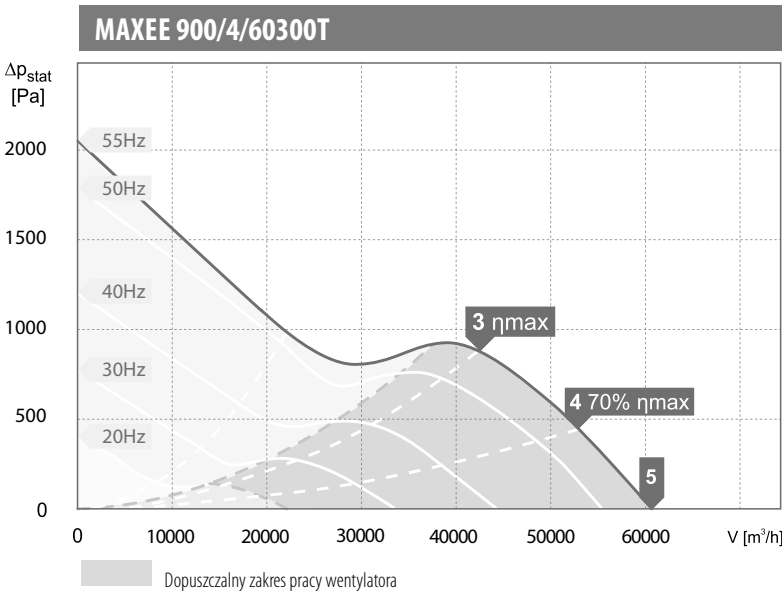
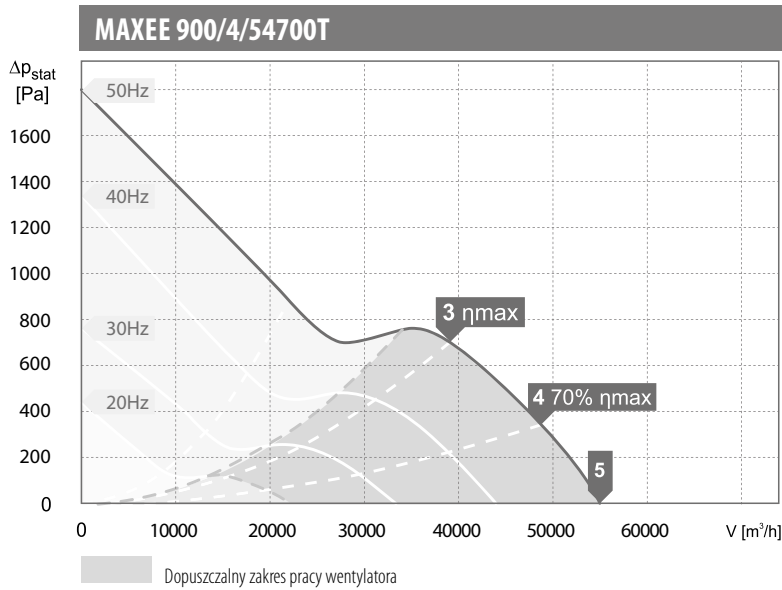

wartości mocy akustycznej L_{WA} [dB(A)]
dla poszczególnych częstotliwości pasm oktaowych [Hz]

Pkt. Pracy	tot	Częstotliwości pasm oktaowych [Hz]							
		63	125	250	500	1000	2000	4000	8000
L_{WA} wlot [dB(A)]									
3	108	81	91	105	101	100	96	91	85
4	111	76	87	109	104	104	99	92	85
5	113	70	83	111	104	104	99	92	85
L_{WA} wylot [dB(A)]									
3	107	81	92	104	101	100	96	91	85
4	112	74	90	110	105	105	99	92	84
5	115	68	89	113	107	107	100	93	84
L_{WA} od obudowy [dB(A)]									
3	90	79	82	85	82	82	77	73	63
4	94	75	79	90	86	88	81	72	62
5	96	68	75	93	87	91	82	72	61

Pkt. Pracy	tot	Częstotliwości pasm oktaowych [Hz]							
		63	125	250	500	1000	2000	4000	8000
L_{WA} wlot [dB(A)]									
3	109	81	93	102	104	104	100	94	86
4	113	81	93	103	108	109	104	98	91
5	112	76	90	100	106	110	104	97	90
L_{WA} wylot [dB(A)]									
3	109	80	94	101	104	103	99	93	86
4	114	78	95	105	109	110	105	98	89
5	115	72	93	105	110	112	106	98	89
L_{WA} od obudowy [dB(A)]									
3	90	78	83	83	83	82	77	72	61
4	95	77	82	89	89	90	84	75	65
5	95	70	77	90	88	91	85	74	63

Pkt. Pracy	tot	Częstotliwości pasm oktaowych [Hz]							
		63	125	250	500	1000	2000	4000	8000
L_{WA} wlot [dB(A)]									
3	98	73	81	94	91	90	86	82	76
4	99	67	79	95	93	92	87	83	76
5	99	63	77	96	94	92	87	82	75
L_{WA} wylot [dB(A)]									
3	97	72	83	91	93	91	86	82	74
4	102	67	82	95	100	96	89	82	75
5	102	67	82	95	99	95	88	82	74
L_{WA} od obudowy [dB(A)]									
3	85	75	72	82	76	74	69	60	54
4	87	71	74	84	81	77	70	60	54
5	89	64	76	86	85	79	70	58	52

charakterystyki pracy

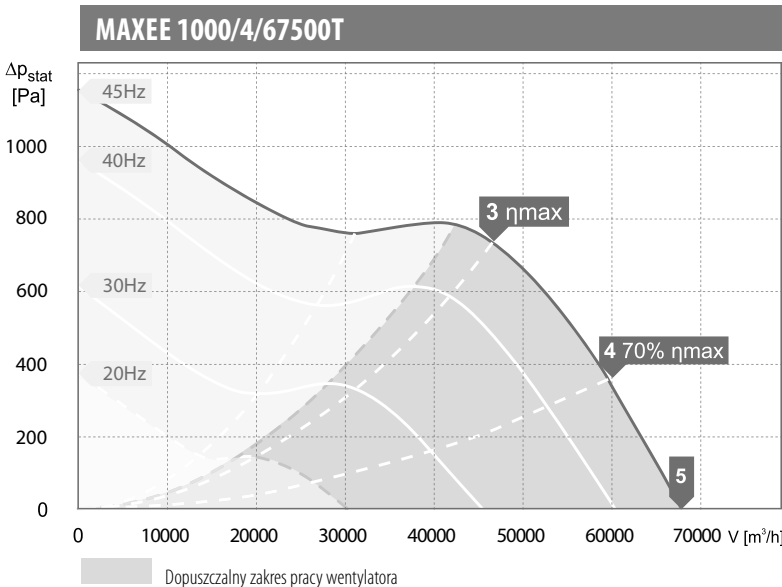
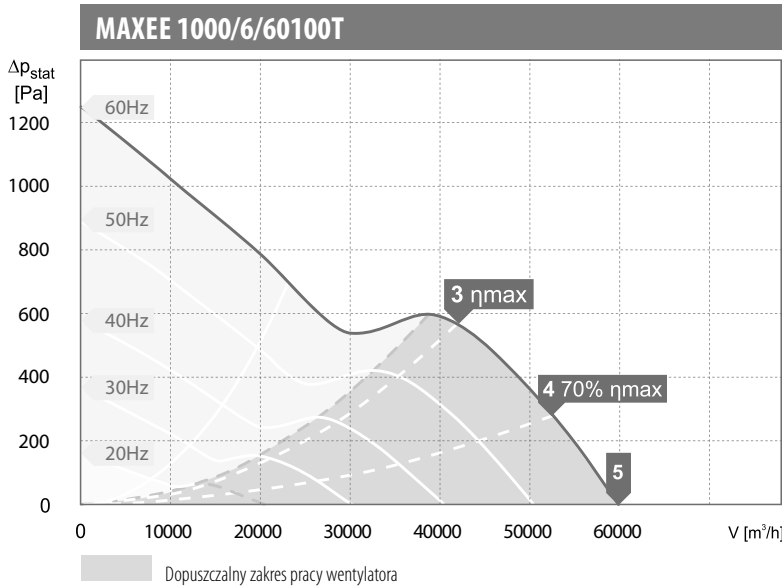
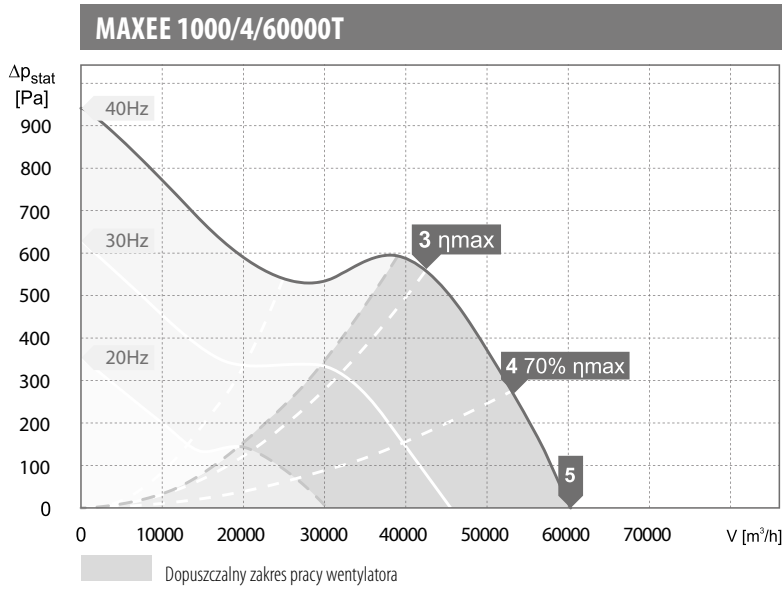

wartości mocy akustycznej L_{WA} [dB(A)]
dla poszczególnych częstotliwości pasm oktaowych [Hz]

Pkt. Pracy	tot	Częstotliwości pasm oktaowych [Hz]							
		63	125	250	500	1000	2000	4000	8000
L_{WA} wlot [dB(A)]									
3	102	80	87	95	97	96	92	87	81
4	104	79	84	96	99	99	94	88	81
5	104	72	79	97	99	100	94	87	80
L_{WA} wylot [dB(A)]									
3	101	81	88	94	96	95	91	86	81
4	104	77	87	96	99	99	93	87	80
5	106	69	85	98	102	102	94	87	80
L_{WA} od obudowy [dB(A)]									
3	85	80	77	77	78	77	72	68	58
4	87	78	76	80	83	81	74	68	58
5	89	72	74	83	85	83	75	67	57

Pkt. Pracy	tot	Częstotliwości pasm oktaowych [Hz]							
		63	125	250	500	1000	2000	4000	8000
L_{WA} wlot [dB(A)]									
3	101	78	87	94	96	95	91	88	82
4	103	71	83	95	99	98	92	87	81
5	104	63	79	94	100	99	93	86	79
L_{WA} wylot [dB(A)]									
3	102	80	89	95	97	96	91	87	80
4	107	64	84	100	104	101	94	87	79
5	106	65	85	99	103	101	94	87	79
L_{WA} od obudowy [dB(A)]									
3	85	79	76	77	79	78	72	66	60
4	89	73	76	84	85	82	74	64	58
5	91	65	74	88	87	83	73	63	56

Pkt. Pracy	tot	Częstotliwości pasm oktaowych [Hz]							
		63	125	250	500	1000	2000	4000	8000
L_{WA} wlot [dB(A)]									
3	106	83	90	101	101	100	96	90	84
4	107	78	86	102	102	102	97	91	84
5	108	73	83	102	102	103	97	91	83
L_{WA} wylot [dB(A)]									
3	106	82	91	100	100	99	95	90	84
4	108	76	89	103	103	103	97	91	83
5	109	71	87	104	104	105	98	91	83
L_{WA} od obudowy [dB(A)]									
3	89	82	82	82	82	82	76	71	61
4	91	76	78	85	85	85	78	71	60
5	92	70	74	87	87	88	79	70	60

charakterystyki pracy

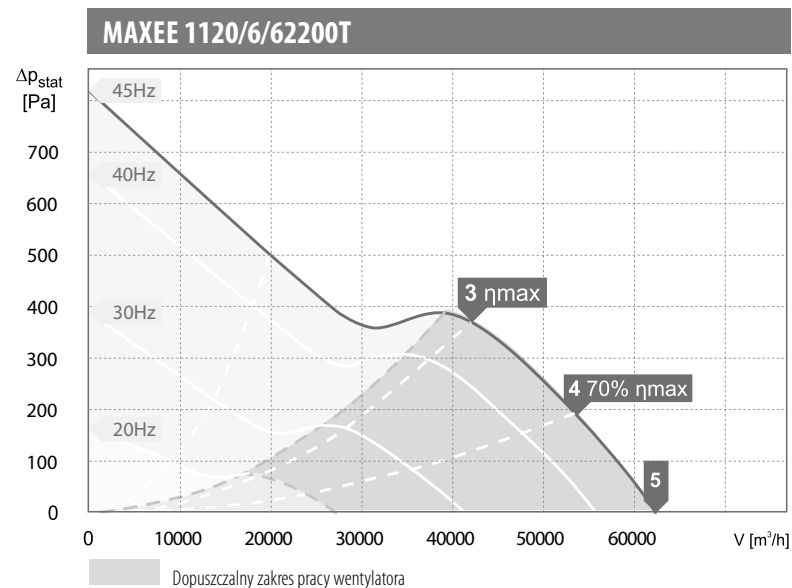
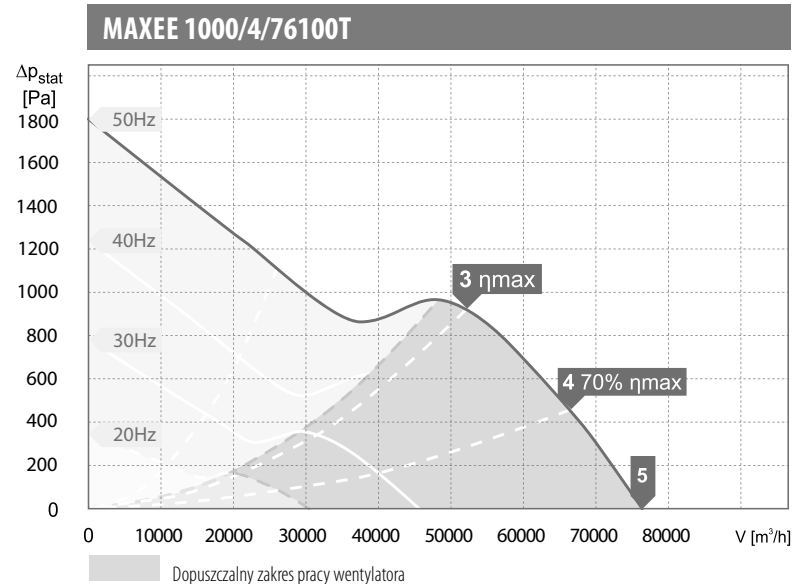
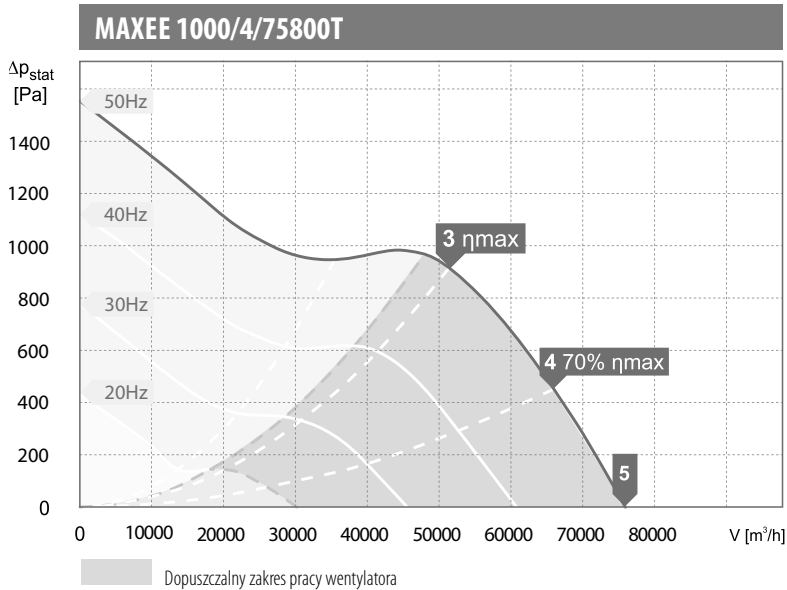

wartości mocy akustycznej L_{WA} [dB(A)]
dla poszczególnych częstotliwości pasm oktaowych [Hz]

Pkt. Pracy	Częstotliwości pasm oktaowych [Hz]								
	tot	63	125	250	500	1000	2000	4000	8000
L_{WA} wlot [dB(A)]									
3	109	82	92	106	102	102	98	92	86
4	113	80	90	110	106	105	101	94	87
5	115	72	85	113	107	106	101	94	87
L_{WA} wylot [dB(A)]									
3	109	82	93	105	102	102	97	92	86
4	114	77	93	111	106	106	101	94	86
5	117	70	91	115	109	109	102	95	86
L_{WA} od obudowy [dB(A)]									
3	91	80	84	86	84	84	79	74	64
4	95	78	82	91	88	90	83	74	64
5	98	70	77	95	89	93	84	74	63

Pkt. Pracy	Częstotliwości pasm oktaowych [Hz]								
	tot	63	125	250	500	1000	2000	4000	8000
L_{WA} wlot [dB(A)]									
3	111	86	94	107	105	104	100	94	87
4	113	80	90	110	106	106	101	95	87
5	115	72	85	113	106	106	101	94	87
L_{WA} wylot [dB(A)]									
3	110	84	94	107	104	103	99	93	86
4	114	78	93	111	107	107	101	95	87
5	117	70	91	115	109	109	102	95	86
L_{WA} od obudowy [dB(A)]									
3	94	83	87	88	86	86	81	74	64
4	96	78	82	92	88	90	83	75	64
5	98	70	77	95	89	93	84	74	63

Pkt. Pracy	Częstotliwości pasm oktaowych [Hz]								
	tot	63	125	250	500	1000	2000	4000	8000
L_{WA} wlot [dB(A)]									
3	100	77	85	95	95	94	90	87	80
4	102	76	85	96	97	96	92	88	81
5	103	71	83	97	99	98	93	88	81
L_{WA} wylot [dB(A)]									
3	101	78	88	94	96	94	90	86	78
4	104	75	87	97	101	98	92	87	79
5	106	75	88	98	102	100	93	87	80
L_{WA} od obudowy [dB(A)]									
3	87	81	76	81	81	78	73	64	59
4	89	79	78	83	84	81	74	65	60
5	92	73	79	85	90	85	75	64	59

charakterystyki pracy

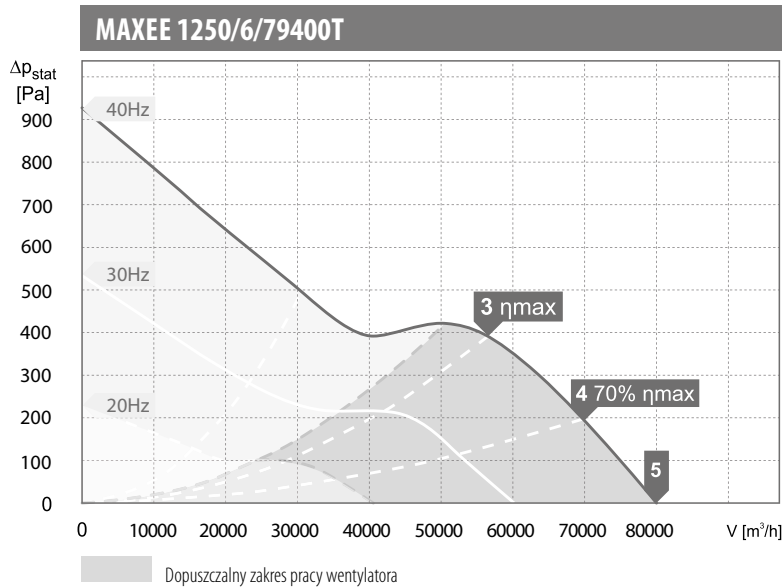
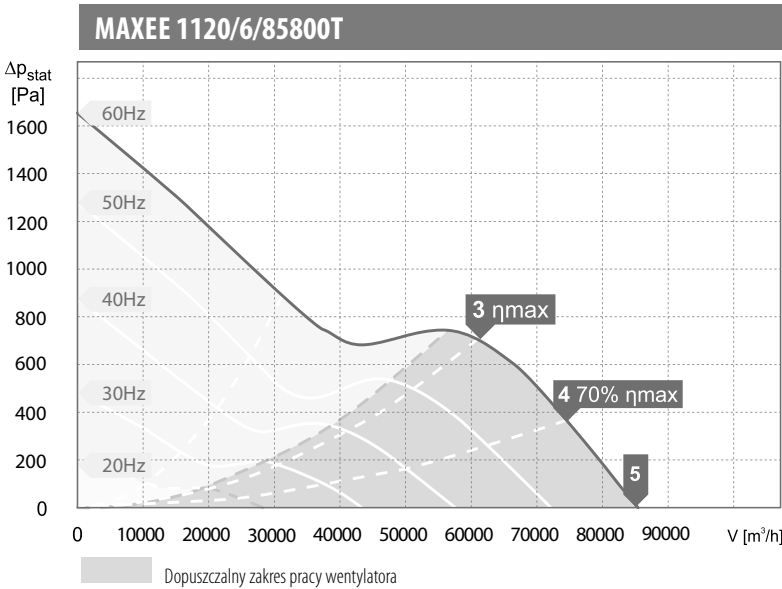
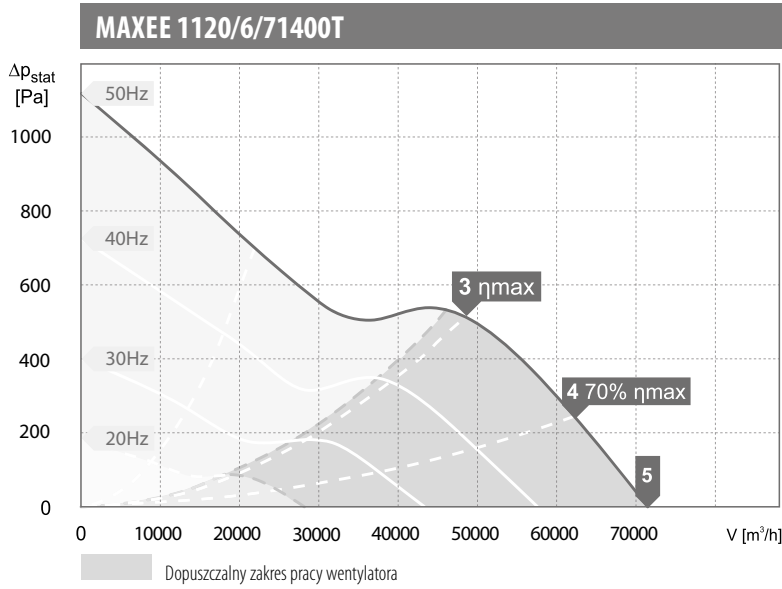

wartości mocy akustycznej L_{WA} [dB(A)]
dla poszczególnych częstotliwości pasm oktaowych [Hz]

Pkt. Pracy	Częstotliwości pasm oktaowych [Hz]								
	tot	63	125	250	500	1000	2000	4000	8000
L_{WA} wlot [dB(A)]									
3	107	83	91	103	100	99	95	91	85
4	107	75	87	103	101	100	95	90	84
5	108	71	85	104	102	101	96	90	83
L_{WA} wylot [dB(A)]									
3	105	83	93	99	101	99	95	91	84
4	110	74	90	103	108	103	97	90	82
5	110	75	90	103	108	103	97	90	83
L_{WA} od obudowy [dB(A)]									
3	93	84	81	91	85	83	78	70	64
4	95	78	82	92	90	85	78	67	62
5	97	73	84	94	93	87	78	66	61

Pkt. Pracy	Częstotliwości pasm oktaowych [Hz]								
	tot	63	125	250	500	1000	2000	4000	8000
L_{WA} wlot [dB(A)]									
3	109	87	95	102	104	103	100	95	90
4	111	81	92	103	106	106	100	95	89
5	112	72	87	103	108	108	101	95	88
L_{WA} wylot [dB(A)]									
3	110	86	97	102	105	104	99	94	88
4	115	73	93	108	112	109	102	95	87
5	115	74	93	107	112	109	102	95	87
L_{WA} od obudowy [dB(A)]									
3	94	88	85	85	89	87	81	74	68
4	96	82	84	91	92	89	82	72	66
5	99	73	83	96	95	91	82	71	65

Pkt. Pracy	Częstotliwości pasm oktaowych [Hz]								
	tot	63	125	250	500	1000	2000	4000	8000
L_{WA} wlot [dB(A)]									
3	101	80	87	93	96	95	92	89	81
4	101	76	85	93	96	96	92	88	81
5	101	72	84	92	97	96	91	87	80
L_{WA} wylot [dB(A)]									
3	101	80	89	93	96	94	91	88	80
4	103	77	89	95	99	97	92	86	79
5	103	76	90	95	99	98	92	86	79
L_{WA} od obudowy [dB(A)]									
3	87	82	77	78	83	78	74	66	61
4	89	79	78	79	86	81	74	64	60
5	91	75	79	79	89	84	73	62	59

charakterystyki pracy

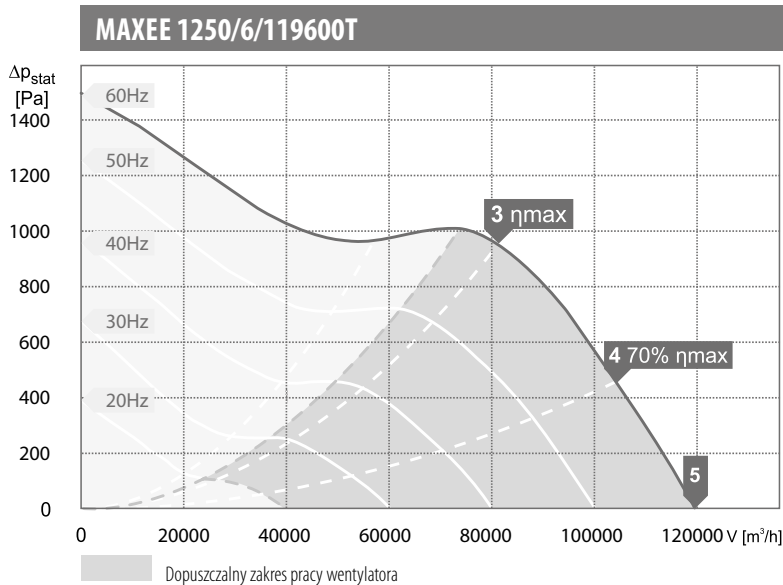
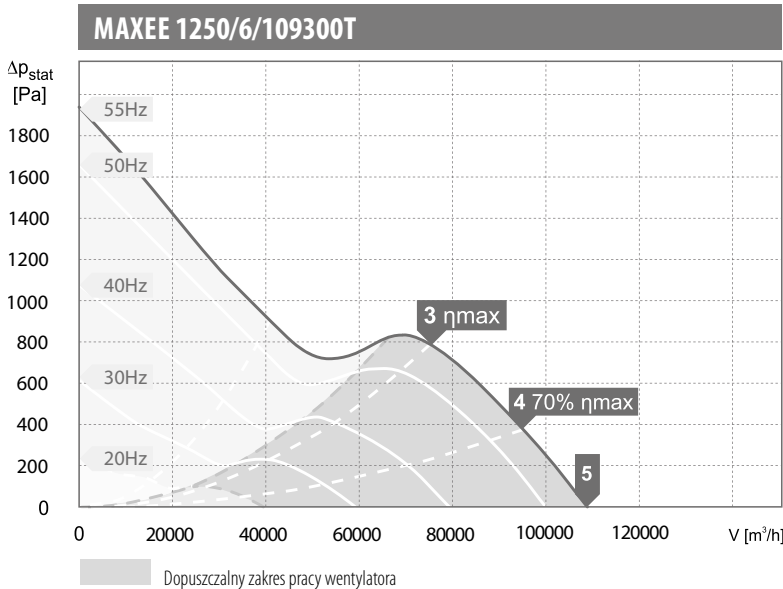
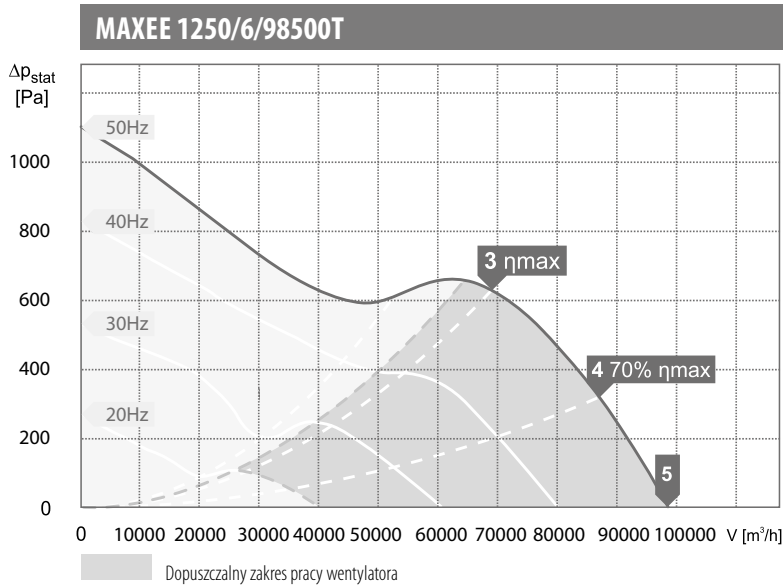

wartości mocy akustycznej L_{WA} [dB(A)]
dla poszczególnych częstotliwości pasm oktaowych [Hz]

Pkt. Pracy	tot	Częstotliwości pasm oktaowych [Hz]							
		63	125	250	500	1000	2000	4000	8000
L_{WA} wlot [dB(A)]									
3	109	83	92	106	103	102	97	94	87
4	110	77	89	106	104	103	98	93	86
5	111	74	89	107	105	104	99	93	87
L_{WA} wylot [dB(A)]									
3	109	84	94	103	104	103	98	93	85
4	113	77	92	105	110	106	99	92	85
5	113	78	93	106	111	106	100	93	86
L_{WA} od obudowy [dB(A)]									
3	96	88	83	94	88	86	80	72	66
4	98	80	85	95	92	88	81	70	64
5	100	76	88	97	96	90	82	70	64

Pkt. Pracy	tot	Częstotliwości pasm oktaowych [Hz]							
		63	125	250	500	1000	2000	4000	8000
L_{WA} wlot [dB(A)]									
3	109	85	93	104	104	103	99	95	89
4	111	81	92	105	106	105	100	95	89
5	112	74	89	105	108	107	101	95	89
L_{WA} wylot [dB(A)]									
3	110	83	95	103	105	104	99	94	87
4	115	77	94	106	111	109	102	95	88
5	115	77	94	107	112	109	102	96	88
L_{WA} od obudowy [dB(A)]									
3	95	87	84	90	88	87	81	73	67
4	98	83	85	94	93	90	83	73	67
5	101	76	85	98	97	92	83	72	66

Pkt. Pracy	tot	Częstotliwości pasm oktaowych [Hz]							
		63	125	250	500	1000	2000	4000	8000
L_{WA} wlot [dB(A)]									
3	112	89	98	105	107	106	102	98	93
4	113	82	94	105	109	108	103	98	91
5	115	74	90	106	111	111	104	98	91
L_{WA} wylot [dB(A)]									
3	112	89	99	105	108	106	102	97	91
4	117	76	95	110	114	111	104	98	90
5	118	77	96	110	115	112	105	98	90
L_{WA} od obudowy [dB(A)]									
3	96	89	87	88	91	89	83	77	71
4	99	84	86	94	95	92	84	75	69
5	102	76	85	99	98	94	85	74	67